

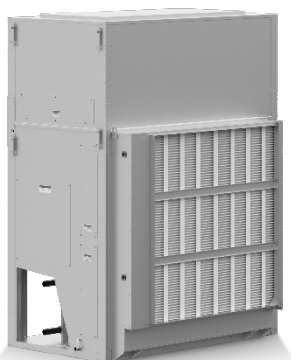

# SA SERIES

## Vertical Self-Contained Units and Indoor Air Handling Units



## Installation, Operation & Maintenance



**! WARNING**

**QUALIFIED INSTALLER**

Improper installation, adjustment, alteration, service or maintenance can cause property damage, personal injury or loss of life. Startup and service must be performed by a Factory Trained Service Technician. A copy of this IOM should be kept with the unit.

**! WARNING**

If the information in this manual is not followed exactly, a fire or explosion may result causing property damage, personal injury or loss of life.

**! WARNING**

**FOR YOUR SAFETY**

Do not store or use gasoline or other flammable vapors and liquids in the vicinity of this or any other appliance.







## Table of Contents

|  |    |
|--|----|
| Safety .....   | 6  |
| SA Series Feature String Nomenclature .....                    | 11 |
| General Information.....                                       | 16 |
| Codes and Ordinances .....                                     | 16 |
| Receiving Unit.....  | 16 |
| Storage.....   | 17 |
| Direct Expansion (DX) Systems .....                            | 17 |
| Wiring Diagrams .....  | 18 |
| Condensate Drain Pans.....                                     | 18 |
| Unit Size.....   | 18 |
| Installation.....  | 19 |
| Locating the Unit.....   | 19 |
| Lifting and Handling the Unit.....                             | 19 |
| Split Unit Assembly .....                                      | 26 |
| Refrigerant-to-Water Heat Exchanger.....                       | 29 |
| Open Loop Applications .....                                   | 29 |
| Freezing Water in the Heat Exchanger .....                     | 29 |
| Water Piping .....   | 30 |
| Braze Plate Heat Exchanger Cleaning .....                      | 33 |
| Electrical.....  | 33 |
| Cutting Electrical Openings.....                               | 34 |
| Thermostat Control Wiring.....                                 | 35 |
| Duct Connection.....   | 36 |
| Condensate Drain Piping.....                                   | 36 |
| Waterside Economizer .....                                     | 37 |
| Hot Water Coil .....   | 41 |
| Chilled Water Coil.....  | 41 |
| Startup.....   | 41 |
| Supply Fans .....  | 41 |
| Supply Fan Spring Isolator Adjustment.....                     | 41 |
| Supply Fan Removal.....  | 43 |
| Fan Airflow Adjustment .....                                   | 43 |
| Filters.....   | 45 |
| Adjusting Refrigerant Charge .....                             | 45 |
| Freeze Stat Startup.....                                       | 47 |
| Operation.....   | 48 |
| Steam or Hot Water Preheating Operation .....                  | 48 |
| Chilled Water or Non-Compressorized DX Cooling Operation ..... | 48 |
| Packaged DX Cooling Operation and Control .....                | 48 |
| Maintenance.....   | 48 |
| DX Cooling .....   | 48 |
| Condensate Drain Pans.....                                     | 48 |

|   |    |
|---|----|
| E-Coated Coil Cleaning.....                           | 49 |
| Supply Fans .....                                     | 51 |
| Phase and Brownout Protection Module.....             | 52 |
| Filter Replacement .....                              | 54 |
| Replacement Parts .....                               | 55 |
| AAON Warranty, Service, and Parts Department.....     | 55 |
| Appendix A - Heat Exchanger Corrosion Resistance..... | 56 |
| SA Series Startup Form .....                          | 58 |
| Maintenance Log .....                                 | 62 |
| Literature Change History.....                        | 71 |

J000236 (V04330) · Rev. A · 240502

## Index of Tables and Figures

### Tables:

|   |    |
|---|----|
| TABLE 1 - SA SERIES MODELS .....  | 20 |
| TABLE 2- GLYCOL FREEZING POINTS (METRIC) .....                            | 32 |
| TABLE 3 GLYCOL FREEZING POINTS (IMPERIAL) .....                           | 32 |
| TABLE 4 - CONDENSER WATER CONNECTIONS.....                                | 33 |
| TABLE 5 - CONDENSER PRESSURE DROPS (EACH HEAT EXCHANGER) .....            | 34 |
| TABLE 6 - CONTROL WIRING.....   | 38 |
| TABLE 7 – 35 KAIC FUSE SIZING .....                                       | 39 |
| TABLE 8 – 65 KAIC FUSE SIZING .....                                       | 39 |
| TABLE 9 - DUCT CONNECTION SIZES (METRIC).....                             | 39 |
| TABLE 10 - DUCT CONNECTION SIZES (IMPERIAL) .....                         | 39 |
| TABLE 11 - DRAIN TRAP DIMENSIONS (METRIC).....                            | 40 |
| TABLE 12 - DRAIN TRAP DIMENSIONS (IMPERIAL).....                          | 40 |
| TABLE 13 -MIN AND MAX WATER PRESSURE AND TEMPS .....                      | 45 |
| TABLE 14 - ACCEPTABLE REFRIGERANT CIRCUIT VALUES (METRIC).....            | 50 |
| TABLE 15 - ACCEPTABLE REFRIGERANT CIRCUIT VALUES (IMPERIAL) .....         | 50 |
| TABLE 16 - R-410A REFRIGERANT TEMPERATURE-PRESSURE CHART (METRIC) .....   | 51 |
| TABLE 17 - R-410A REFRIGERANT TEMPERATURE-PRESSURE CHART (IMPERIAL) ..... | 52 |
| TABLE 18 - 23-35 TONS, PRE FILTERS .....                                  | 59 |
| TABLE 19 - 45-70 TONS, PRE FILTERS .....                                  | 59 |
| TABLE 20 - 23-35 TONS, UNIT FILTERS.....                                  | 59 |
| TABLE 21 - 45-70 TONS, UNIT FILTERS.....                                  | 60 |

### Figures:

|  |    |
|--|----|
| FIGURE 1 - SA SERIES UNIT WITH RIGHT INTAKE .....                          | 21 |
| FIGURE 2 - ONE PIECE SINGLE UNIT LIFTING DETAILS .....                     | 22 |
| FIGURE 3 - TWO PIECE SINGLE UNIT COIL SECTION LIFTING DETAILS .....        | 23 |
| FIGURE 4 - TWO PIECE SINGLE UNIT FAN SECTION LIFTING DETAILS .....         | 24 |
| FIGURE 5- ONE PIECE DUAL UNIT LIFTING DETAILS .....                        | 25 |
| FIGURE 6 - TWO PIECE DUAL UNIT COIL SECTION LIFTING DETAILS .....          | 26 |
| FIGURE 7 - TWO PIECE DUAL UNIT FAN SECTION LIFTING DETAILS.....            | 27 |
| FIGURE 8- DUAL UNIT WITHOUT SPLICES AND BEFORE BEING BOLTED TOGETHER. .... | 29 |
| FIGURE 9 - DUAL UNIT ASSEMBLY DETAILS.....                                 | 29 |
| FIGURE 10 - DUAL UNIT WITH SPLICES AFTER BEING BOLTED TOGETHER. ....       | 30 |
| FIGURE 11 - DRAIN TRAP .....   | 40 |
| FIGURE 12 - SA SERIES UNIT WITH WATERSIDE ECONOMIZER PIPING .....          | 42 |
| FIGURE 13 - AIR CONDITIONER WATERSIDE ECONOMIZER PIPING KIT.....           | 43 |
| FIGURE 14 - AIR CONDITIONER WATERSIDE ECONOMIZER BACK VIEW.....            | 43 |
| FIGURE 15 - WATER-SOURCE HEAT PUMP WATERSIDE ECONOMIZER PIPING KIT .....   | 44 |
| FIGURE 16 - WATER-SOURCE HEAT PUMP WATERSIDE ECONOMIZER BACK VIEW .....    | 44 |
| FIGURE 17 - SPRING ISOLATION.....  | 46 |
| FIGURE 18 - BACK VIEW WITH SUPPLY FAN ACCESS PANEL REMOVED .....           | 47 |
| FIGURE 19 - FRONT VIEW WITH SUPPLY FAN ACCESS DOOR OPEN .....              | 47 |
| FIGURE 20 - BLOWER WHEEL WITH BAND.....                                    | 48 |
| FIGURE 21 - SECURING THE BAND .....  | 48 |
| FIGURE 22 - BAND TABS.....   | 48 |
| FIGURE 23 - BLOWER WHEEL .....   | 48 |

## Safety

Attention should be paid to the following statements:

**NOTE** - Notes are intended to clarify the unit installation, operation and maintenance.

**⚠ CAUTION** - Caution statements are given to prevent actions that may result in equipment damage, property damage, or personal injury.

**⚠ WARNING** - Warning statements are given to prevent actions that could result in equipment damage, property damage, personal injury or death.

**⚠ DANGER** - Danger statements are given to prevent actions that will result in equipment damage, property damage, severe personal injury or death.

### **⚠ WARNING**

#### **ELECTRIC SHOCK, FIRE OR EXPLOSION HAZARD**

Failure to follow safety warnings exactly could result in dangerous operation, serious injury, death or property damage.

Improper servicing could result in dangerous operation, serious injury, death or property damage.

- Before servicing, disconnect all electrical power to the unit. More than one disconnect may be provided.
- When servicing controls, label all wires prior to disconnecting. Reconnect wires correctly.
- Verify proper operation after servicing. Secure all doors with key-lock or nut and bolt.

### **⚠ WARNING**

Electric shock hazard. Before servicing, disconnect all electrical power to the unit, including remote disconnects, to avoid shock hazard or injury from rotating parts. Follow proper Lockout-Tagout procedures.

### **⚠ WARNING**

#### **FIRE, EXPLOSION OR CARBON MONOXIDE POISONING HAZARD**

Failure to replace proper controls could result in fire, explosion or carbon monoxide poisoning. Failure to follow safety warnings exactly could result in serious injury, death or property damage. Do not store or use gasoline or other flammable vapors and liquids in the vicinity of this appliance.



**! WARNING**

During installation, testing, servicing and troubleshooting of the equipment it may be necessary to work with live electrical components. Only a qualified licensed electrician or individual properly trained in handling live electrical components shall perform these tasks.

Standard NFPA-70E, an OSHA regulation requiring an Arc Flash Boundary to be field established and marked for identification of where appropriate Personal Protective Equipment (PPE) be worn, should be followed.

**! WARNING**

**GROUNDING REQUIRED**

All field installed wiring must be completed by qualified personnel. Field installed wiring must comply with NEC/CEC, local and state electrical code requirements. Failure to follow code requirements could result in serious injury or death. Provide proper unit ground in accordance with these code requirements.

**! WARNING**

**VARIABLE FREQUENCY DRIVES**

Do not leave VFDs unattended in hand mode or manual bypass. Damage to personnel or equipment can occur if left unattended. When in hand mode or manual bypass mode VFDs will not respond to controls or alarms.

**! CAUTION**

Electric motor over-current protection and overload protection may be a function of the Variable Frequency Drive to which the motors are wired. Never defeat the VFD motor overload feature. The overload ampere setting must not exceed 115% of the electric motors FLA rating as shown on the motor nameplate.

**! WARNING**

**UNIT HANDLING**

To prevent injury or death lifting equipment capacity shall exceed unit weight by an adequate safety factor. Always test-lift unit not more than 61 centimeters (24 inches) high to verify proper center of gravity lift point to avoid unit damage, injury or death.

**! WARNING**

**ROTATING COMPONENTS**

Unit contains fans with moving parts that can cause serious injury. Do not open door containing fans until the power to the unit has been disconnected and fan wheel has stopped rotating.

**! CAUTION**

Failure to properly drain and vent coils when not in use during freezing temperature may result in coil and equipment damage.

**! CAUTION**

Rotation must be checked on all MOTORS AND COMPRESSORS of 3 phase units at startup by a qualified service technician. Scroll compressors are directional and can be damaged if rotated in the wrong direction. Compressor rotation must be checked using suction and discharge gauges. Fan motor rotation should be checked for proper operation. Alterations should only be made at the unit power connection

**! WARNING**

**WATER PRESSURE**

Prior to connection of condensing water supply, verify water pressure is less than maximum pressure shown on unit nameplate. To prevent injury or death due to instantaneous release of high pressure water, relief valves should be field supplied on system water piping.

**! WARNING**

Do not use oxygen, acetylene or air in place of refrigerant and dry nitrogen for leak testing. A violent explosion may result causing injury or death.

**! WARNING**

Always use a pressure regulator, valves and gauges to control incoming pressures when pressure testing a system. Excessive pressure may cause line ruptures, equipment damage or an explosion which may result in injury or death.

**! WARNING**

Do not work in a closed area where refrigerant or nitrogen gases may be leaking. A sufficient quantity of vapors may be present and cause injury or death.

**! CAUTION**

Do not clean DX refrigerant coils with hot water or steam. The use of hot water or steam on refrigerant coils will cause high pressure inside the coil tubing and damage to the coil.

**! CAUTION**

To prevent damage to the unit, do not use acidic chemical coil cleaners. Do not use alkaline chemical coil cleaners with a pH value greater than 8.5, after mixing, without first using an aluminum corrosion inhibitor in the cleaning solution.

**! WARNING**

Some chemical coil cleaning compounds are caustic or toxic. Use these substances only in accordance with the manufacturer's usage instructions. Failure to follow instructions may result in equipment damage, injury or death.

**! CAUTION**

Door compartments containing hazardous voltage or rotating parts are equipped with door latches to allow locks. Door latch are shipped with nut and bolts requiring tooled access. If you do not replace the shipping hardware with a pad lock always re-install the nut & bolt after closing the door.

**! CAUTION**

Cleaning the cooling tower or the condenser water loop with harsh chemicals, such as hydrochloric acid (muriatic acid) or chlorine, can damage the water-cooled condenser. Care should be taken to avoid allowing chemicals to enter the water-cooled condenser. See Appendix A - Heat Exchanger Corrosion Resistance for more information.

**! WARNING**

Never attempt to open an access door or remove a panel while the unit is running. Pressure in the unit can cause excessive force against the panel.

**! WARNING**

**OPEN LOOP APPLICATIONS**

Failure of the condenser as a result of chemical corrosion is excluded from coverage under AAON Inc. warranties and the heat exchanger manufacturer's warranties.

**! WARNING**

**WATER FREEZING**

Failure of the condenser due to freezing will allow water to enter the refrigerant circuit and will cause extensive damage to the refrigerant circuit components. Any damage to the equipment as a result of water freezing in the condenser is excluded from coverage under AAON warranties and the heat exchanger manufacturer warranties.

**! CAUTION**

PVC (Polyvinyl Chloride) and CPVC (Chlorinated Polyvinyl Chloride) are vulnerable to attack by certain chemicals. Polyolester (POE) oils used with R-410A and other refrigerants, even in trace amounts, in a PVC or CPVC piping system will result in stress cracking of the piping and fittings and complete piping system failure.

**! WARNING**

Do not weld or cut foam panel with plasma cutters or a cutting torch – When burnt the foam produces dangerous fumes.

**! WARNING**

Ensure that sufficient dampers will be open to provide air path before fan is allowed to run.

**! WARNING**

This appliance is not intended for use by persons with reduced physical, sensory or mental capabilities, or lack of experience and knowledge, unless they have been given supervision or instruction concerning use of the appliance by a person responsible for their safety. Children must be supervised around this appliance.

**! WARNING**

**COMPRESSOR CYCLING**

**5 MINUTE MINIMUM OFF TIME**

To prevent motor overheating compressors must cycle off for a minimum of 5 minutes.

**5 MINUTE MINIMUM ON TIME**

To maintain the proper oil level compressors must cycle on for a minimum of 5 minutes.

The cycle rate must not exceed 6 starts per hour.

**! CAUTION**

In order to avoid a hazard due to inadvertent resetting of the THERMAL CUT-OUT, this appliance must not be supplied through an external switching device, such as a timer, or connected to a circuit that is regularly switched on and off by the utility.

**! WARNING**

Units with VFD driven motors/compressors have adjustable overload settings. These are set by the AAON factory for the protection of these motors/compressors and must not be adjusted over this factory setpoint or bypassed.

**! CAUTION**

Unit power supply wire must be only copper or aluminum.

 **CAUTION**

Disconnect power to the unit before servicing UV-C lamps

 **CAUTION**

Doors and panels with access to UV-C lamps, with possible spectral irradiance exceeding  $1.7 \mu\text{W}/\text{cm}^2$  are provided with an interlock switch. Do not over-ride.

 **WARNING**

Do not operate UV-C lamps outside of the unit.

 **WARNING**

Units containing UV-C Germicidal lamps should not be operated with damage to the cabinet of the unit. UV-C radiation may, even in small doses, cause harm to the eyes and skin.

1. Startup and service must be performed by a Factory Trained Service Technician.
2. The unit is for indoor use only. See General Information section for more unit information.
3. Every unit has a unique equipment nameplate with electrical, operational, and unit clearance specifications. Always refer to the unit nameplate for specific ratings unique to the model you have purchased.
4. These units must not be used for heating or cooling at any time during any phase of construction. Very low return air temperatures, harmful vapors, and misplacement of the filters will damage the unit and its efficiency
5. READ THE ENTIRE INSTALLATION, OPERATION AND MAINTENANCE MANUAL. OTHER IMPORTANT SAFETY PRECAUTIONS ARE PROVIDED THROUGHOUT THIS MANUAL.
6. Keep this manual and all literature safeguarded near or on the unit.





# SA Series Feature String Nomenclature

Model Options : Unit Feature Options

| GEN | SIZE | VLT | CONFIG | A1   | A2 | A3  | A4 | B1   | B2 | B3  | 1A | 1B  | 1C | 1D  | 2 | 3   | 4 | 5A      | 5B | 5C | 6A | 6B         | 6C | 7 | 8 | 9 | 10 | 11 | 12 | 13 | 14A | 14B | 15 | 16 | 17 | 18 | 19 | 20 | 21 | 22 | 23 |  |  |
|-----|------|-----|--------|------|----|-----|----|------|----|-----|----|-----|----|-----|---|-----|---|---------|----|----|----|------------|----|---|---|---|----|----|----|----|-----|-----|----|----|----|----|----|----|----|----|----|--|--|
| SA  | 035  | -3  | -A     | ER09 | -  | 000 |    | AC00 | -  | 000 | -  | 000 | -  | EBF | - | AB0 | - | 0000000 | -  | HA | -  | 000000000B |    |   |   |   |    |    |    |    |     |     |    |    |    |    |    |    |    |    |    |  |  |

**5A: Supply Air Blower Configuration**

- 0 = 2 Blowers + Standard Efficiency Motors
- A = 4 Blowers + Standard Efficiency Motors
- B = 2 Blowers + Premium Efficiency Motors
- C = 4 Blowers + Premium Efficiency Motors
- D = 2 Blowers + Premium Efficiency Motors + 1 VFD
- E = 2 Blowers + Premium Efficiency Motors + 2 VFDs
- F = 4 Blowers + Premium Efficiency Motors + 2 VFDs
- G = 4 Blowers + Premium Efficiency Motors + 4 VFDs
- H = 1 Blower + Standard Efficiency Motor
- J = 1 Blower + Premium Efficiency Motor
- K = 1 Blower + Premium Efficiency Motor + 1 VFD

**5B: Supply Air Blower**

- A = 18.5" Spring Isolated Direct Drive Backward Curved Plenum
- B = 22" Spring Isolated Direct Drive Backward Curved Plenum

**5C: Supply Air Blower Motor**

- C = 1 hp - 1760 rpm
- D = 2 hp - 1760 rpm
- E = 3 hp - 1760 rpm
- F = 5 hp - 1760 rpm
- G = 7.5 hp - 1760 rpm
- H = 10 hp - 1760 rpm
- N = 1 hp - 1140 rpm
- P = 2 hp - 1140 rpm
- Q = 3 hp - 1140 rpm
- R = 5 hp - 1140 rpm
- S = 7.5 hp - 1140 rpm

**6A: Pre Filter Type**

- 0 = No Pre Filter
- A = 2" Pleated - 30% Eff. - MERV 8

**6B: Unit Filter Type**

- 0 = 2" Pleated - 30% Eff. - MERV 8
- A = 4" Pleated - 30% Eff. - MERV 8
- B = 4" Pleated - 65% Eff. - MERV 11
- C = 4" Pleated - 85% Eff. - MERV 13
- D = 4" Pleated - 95% Eff. - MERV 14

**6C: Filter Options**

- 0 = Standard
- A = Clogged Filter Switch
- B = Magnehelic Gauge
- C = Options A + B

**7: Refrigeration Control**

- 0 = Standard
- C = Freeze Stat - Each Circuit

**8: Refrigeration Options**

- 0 = Standard
- D = Modulating Hot Gas Reheat

**9: Refrigeration Accessories**

- 0 = Standard
- A = Sight Glass
- B = Compressor Isolation Valves
- C = Options A + B

**10: Power Options**

- 0 = Standard Power Block

**11: Safety Options**

- 0 = Standard
- C = Supply Air Smoke Detector
- H = Remote Safety Shutdown Terminals
- L = Options C + H

**12: Controls**

- 0 = Standard
- A = Low Limit Controls
- B = Phase and Brown Out Protection
- C = Options A + B







## General Information

SA Series self contained units and indoor air handling units have been designed for indoor installation only. SA Series units can contain spring isolated direct drive backward curved plenum fans, shell and tube or brazed plate water-cooled condensers, R-410A scroll compressors, evaporator coils, chilled water cooling coils, steam or hot water heating coils, waterside economizers, and a single point power connection. Units are assembled, wired, charged and run-tested at the factory. SA Series units are not intended for residential use. Startup and service must be performed by a Factory Trained Service Technician.

### **WARNING**

Improper installation, adjustment, alteration, service or maintenance can cause property damage, personal injury or loss of life. Startup and service must be performed by a Factory Trained Service Technician. A copy of this IOM should be kept with the unit.

### Codes and Ordinances

SA Series units have been tested and certified, by ETL, in accordance with UL Safety Standard 1995 5<sup>th</sup> Edition/ CSA C22.2 , ANSI Safety Standard Z21.47-2016.

System should be sized in accordance with the American Society of Heating, Refrigeration and Air Conditioning Engineers Handbook.

Installation of units must conform to the ICC standards of the International Mechanical Code, the International Building Code, Installation of Air Conditioning and Ventilating Systems Standard, NFPA 90A, and local building, plumbing and waste water codes. All appliances must be

electrically grounded in accordance with local codes, or in the absence of local codes, the current National Electric Code, ANSI/NFPA 70 or the current Canadian Electrical Code CSA C22.1.

### **CAUTION**

The Clean Air Act of 1990 bans the intentional venting of refrigerant as of July 1, 1992. Approved methods of recovery, recycling, or reclaiming must be followed.

### **WARNING**

Coils and sheet metal surfaces present sharp edges and care must be taken when working with equipment.

### **WARNING**

Failure to observe the following instructions will result in premature failure of your system and possible voiding of the warranty.

## **Receiving Unit**

When received, the unit should be checked for damage that might have occurred in transit. If damage is found it should be noted on the carrier's Freight Bill. A request for inspection by carrier's agent should be made in writing at once.

Nameplate should be checked to ensure the correct model sizes and voltages have been received to match the job requirements.

If repairs must be made to damaged goods, notify the factory before any repair action is taken in order to protect the warranty. Certain equipment alteration, repair, and manipulation of equipment without the manufacturer's consent may void the product warranty. Contact the AAON Technical Support for assistance with handling damaged goods, repairs, and freight claims: (918) 382-6450.

**Note:** Upon receipt check shipment for items that ship loose such as remote sensors. Consult order and shipment documentation to identify potential loose-shipped items. Loose-shipped items may have been placed inside unit cabinet for security. Installers and owners must secure all doors with locks or nuts and bolts to prevent unauthorized access.

## Storage

If installation will not occur immediately following delivery, store equipment in a dry protected area away from construction traffic and in the proper orientation as marked on the packaging with all internal packaging in place. Secure all loose-shipped items.

## Direct Expansion (DX) Systems

 **WARNING**

**COMPRESSOR CYCLING**

**5 MINUTE MINIMUM OFF TIME**  
To prevent motor overheating compressors must cycle off for a minimum of 5 minutes.

**5 MINUTE MINIMUM ON TIME**  
To maintain the proper oil level compressors must cycle on for a minimum of 5 minutes.

The cycle rate must not exceed 6 starts per hour.

All water-cooled condenser DX systems are factory assembled, leak tested, charged with R-410A refrigerant, and run tested.

All DX systems include evaporator coils, liquid line filter dryers, thermostatic expansion valves (TXV), and scroll compressors.

 **CAUTION**

**CRANKCASE HEATER**

Some units are equipped with compressor crankcase heaters, which should be energized at least 24 hours prior to cooling operation, to clear any liquid refrigerant from the compressors.

Never turn off the main power supply to the unit, except for servicing, emergency, or complete shutdown of the unit. When power is cut off from the unit crankcase heaters cannot prevent refrigerant migration into the compressors. This means the compressor may cool down and liquid refrigerant may accumulate in the compressor. The compressor is designed to pump refrigerant gas and damage may occur when power is restored.

If power to the unit must be off for more than an hour, turn the thermostat system switch to "OFF", or turn the unit off at the control panel, and leave the unit off until the main power switch has been turned on again for at least 24 hours for units with compressor crankcase heaters. This will give the crankcase heater time to clear any liquid accumulation out of the compressor before it is started.

Always control the unit from the thermostat, or control panel, never at the main power supply, except for emergency or complete shutdown of the unit.

During the cooling season, if the airflow is reduced due to dirty air filters or any other reason, the cooling coils can get too cold which will cause excessive liquid to return to the compressor. As the liquid concentration builds up, oil is washed out of

the compressor, leaving it starved for lubrication.

The compressor life will be seriously shortened by reduced lubrication and the pumping of excessive amounts of liquid oil and refrigerant.

**Wiring Diagrams**

Unit specific wiring diagrams are laminated and affixed inside the controls compartment door.

**Condensate Drain Pans**

Units require drain p-traps and lines to be connected to the condensate drain pans of the unit. The lines should be the same pipe size or larger than the drain connection, include a p-trap, and pitch downward toward drain. An air break should be used with long runs of condensate lines.

Waterside economizer coil units include a separate condensate drain pan which drains into the evaporator coil drain pan. No additional drain line is needed for the waterside economizer drain pan.

|  |
|--|
|  <b>CAUTION</b>                           |
| <p>Unit should not be operated without a p-trap. Failure to install a p-trap may result in overflow of condensate water.</p> |

**Unit Size**

Units are modular and composed of combination of the four standard unit sizes, SA-023, SA-028, SA-030, and SA-035.

Table 1 - SA Series Models

| Model  | Cabinet Type | Intake               | Cabinet 1 | Cabinet 2 |
|--------|--------------|----------------------|-----------|-----------|
| SA-023 | Single       | Left or Right Side   | SA-023    |           |
| SA-028 |              |                      | SA-028    |           |
| SA-030 |              |                      | SA-030    |           |
| SA-035 |              |                      | SA-035    |           |
| SA-045 | Dual         | Left and Right Sides | SA-023    | SA-023    |
| SA-050 |              |                      | SA-023    | SA-028    |
| SA-055 |              |                      | SA-028    | SA-028    |
| SA-058 |              |                      | SA-028    | SA-030    |
| SA-060 |              |                      | SA-030    | SA-030    |
| SA-065 |              |                      | SA-030    | SA-035    |
| SA-070 |              |                      | SA-035    | SA-035    |

## Installation

### Locating the Unit

Placement of the unit relative to ductwork, electrical and plumbing must be carefully considered. Return air plenum or duct can be mounted directly to the return air flanges. Use flexible gasket material to seal the duct to the unit.

Verify floor or foundation can support the total unit weight, including accessory weights. Unit must be level in both horizontal axes to support the unit and reduce noise and vibration from the unit.

Allow adequate service clearances as shown on the unit nameplate and unit drawing. Consult your local building codes for additional service clearance requirements.

Allow adequate space for piping access and panel removal. Condenser water piping and condensate drain connections are near the bottom on the back of the unit.



Figure 1 - SA Series Unit with Right Intake

### Lifting and Handling the Unit

Before lifting unit, be sure that all shipping material has been removed from unit.

#### **WARNING**

#### **UNIT HANDLING**

Incorrect lifting can cause damage to the unit, injury or death. Lifting equipment capacity should exceed unit weight by an adequate safety factor. Always test lift unit not more than 61 centimeters (24 inches) high to verify proper center of gravity lift point.

If cables or chains are used to hoist the unit care should be taken to prevent damage to the cabinet.

Secure hooks and cables at the all lift points provided near the fan section at the top of the unit.

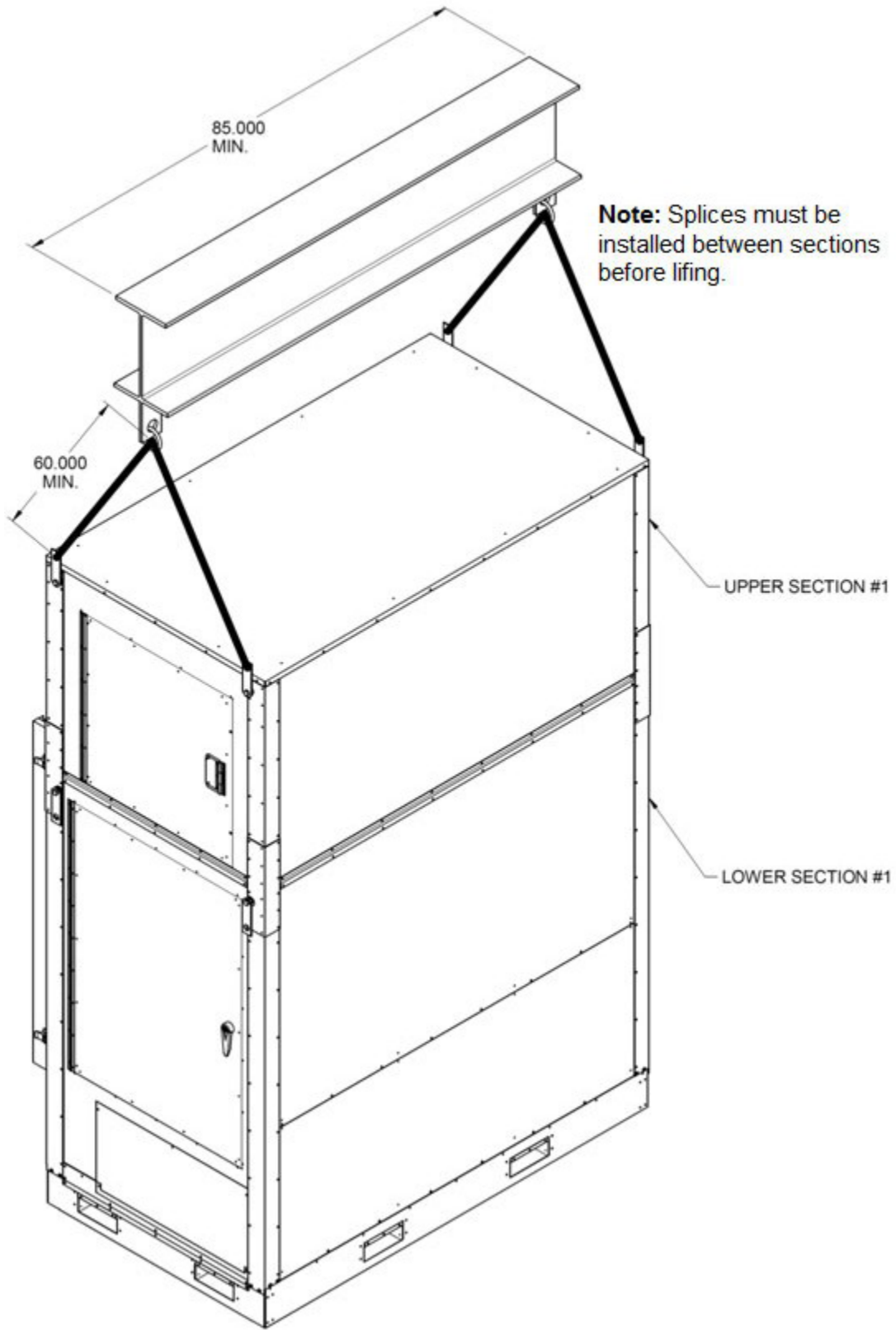

Figure 2 - One Piece Single Unit Lifting Details



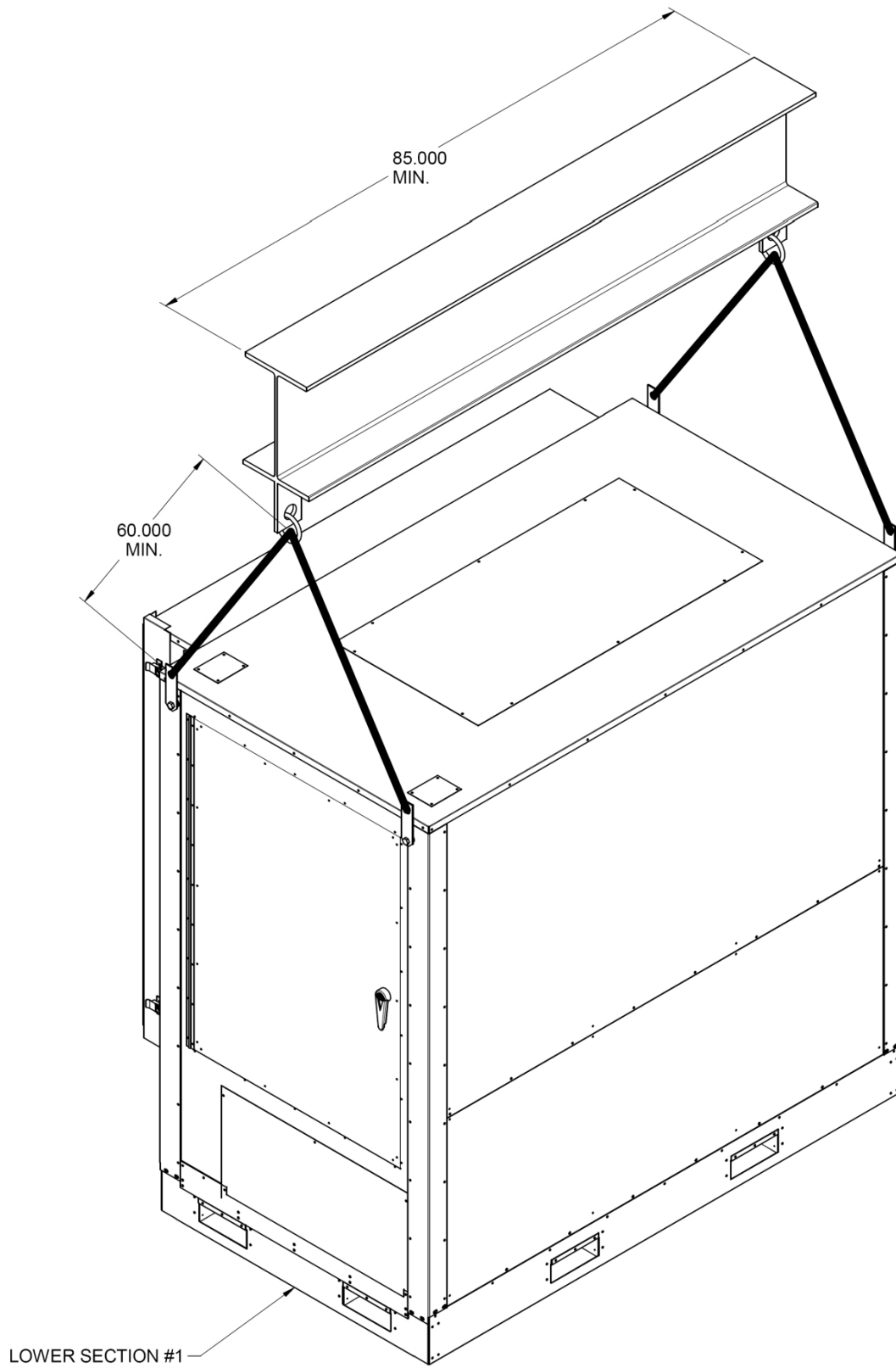

Figure 3 - Two Piece Single Unit Coil Section Lifting Details

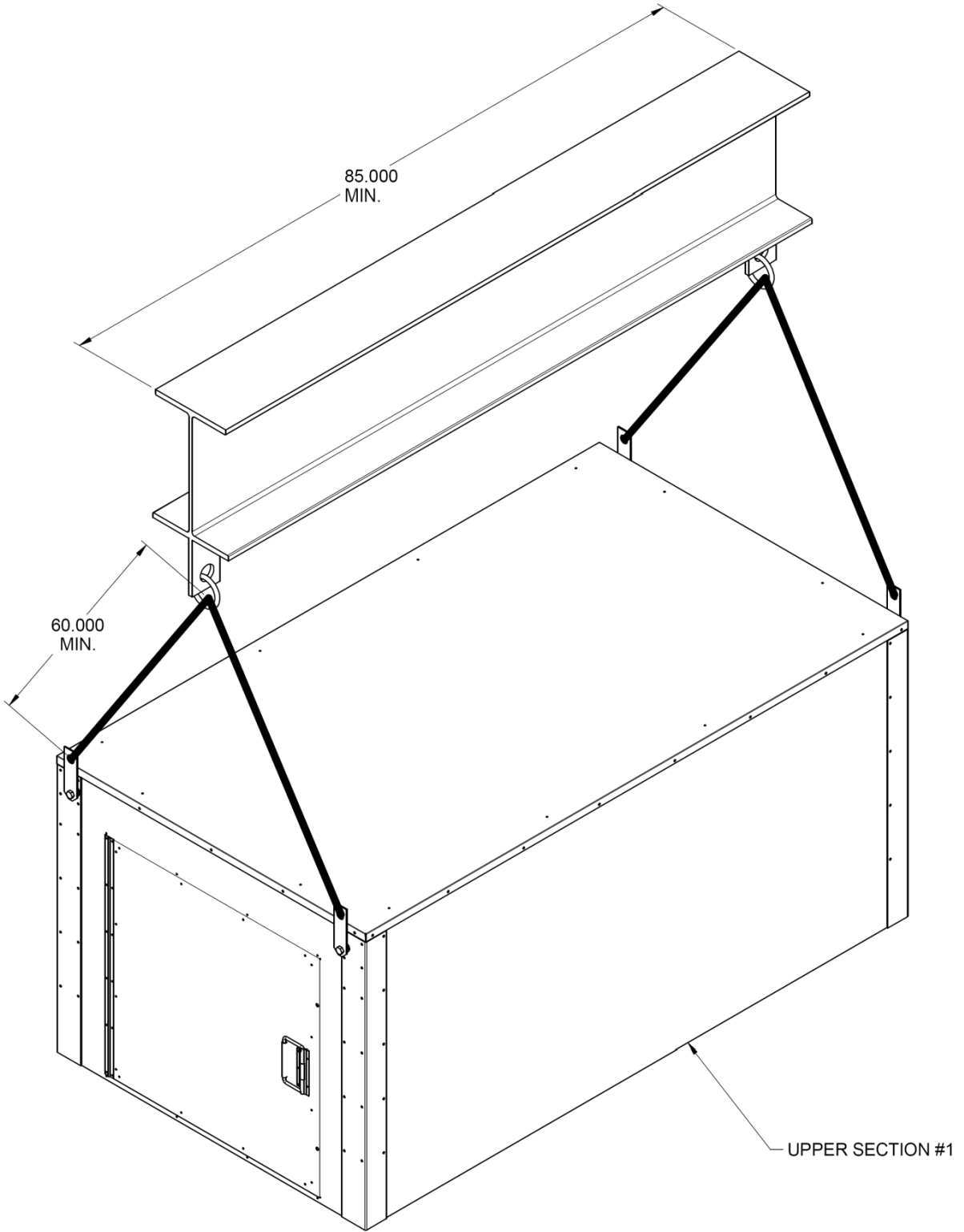

Figure 4 - Two Piece Single Unit Fan Section Lifting Details

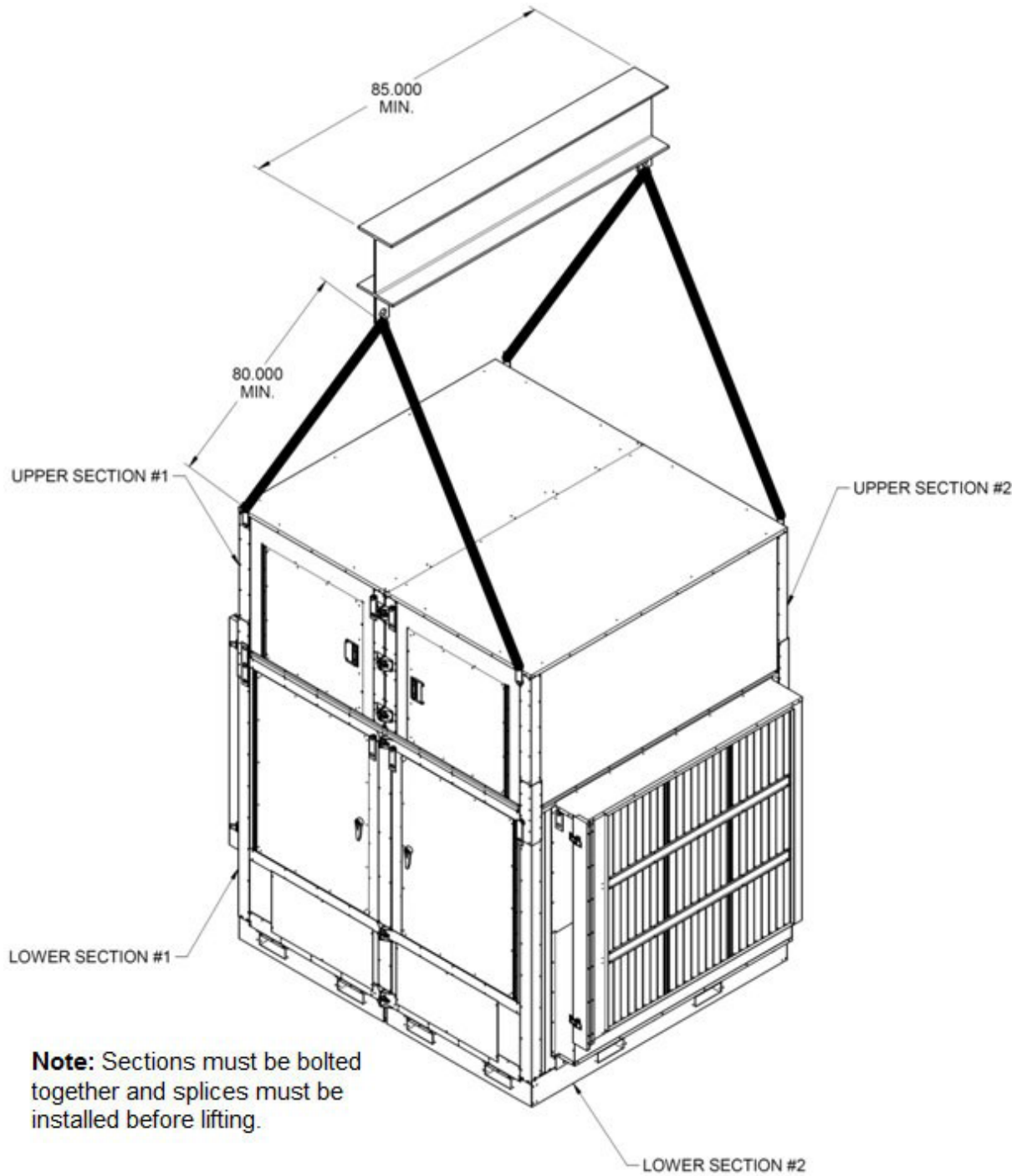

Figure 5- One Piece Dual Unit Lifting Details

**Note:** Sections must be bolted together before lifting.

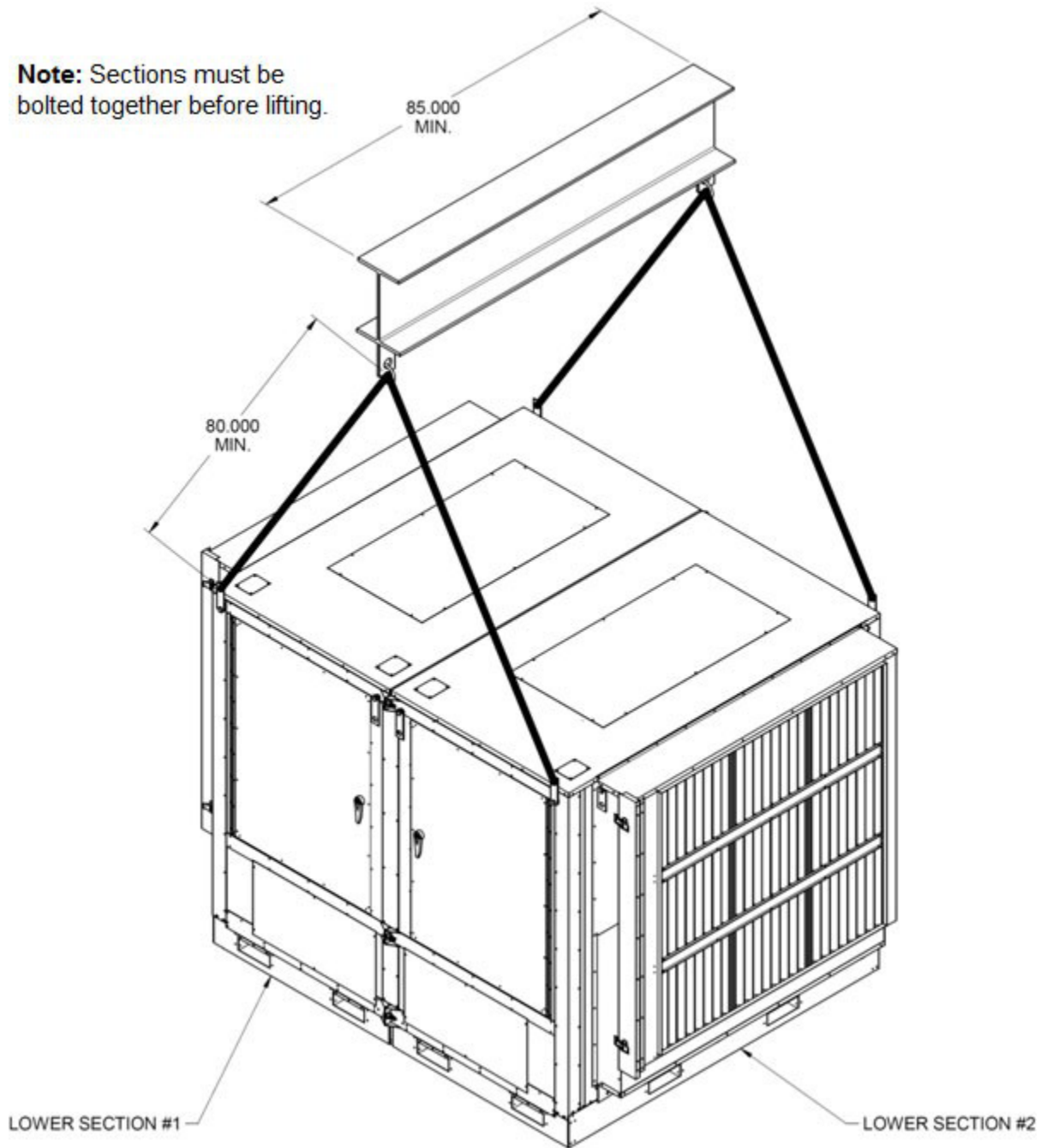

Figure 6 - Two Piece Dual Unit Coil Section Lifting Details

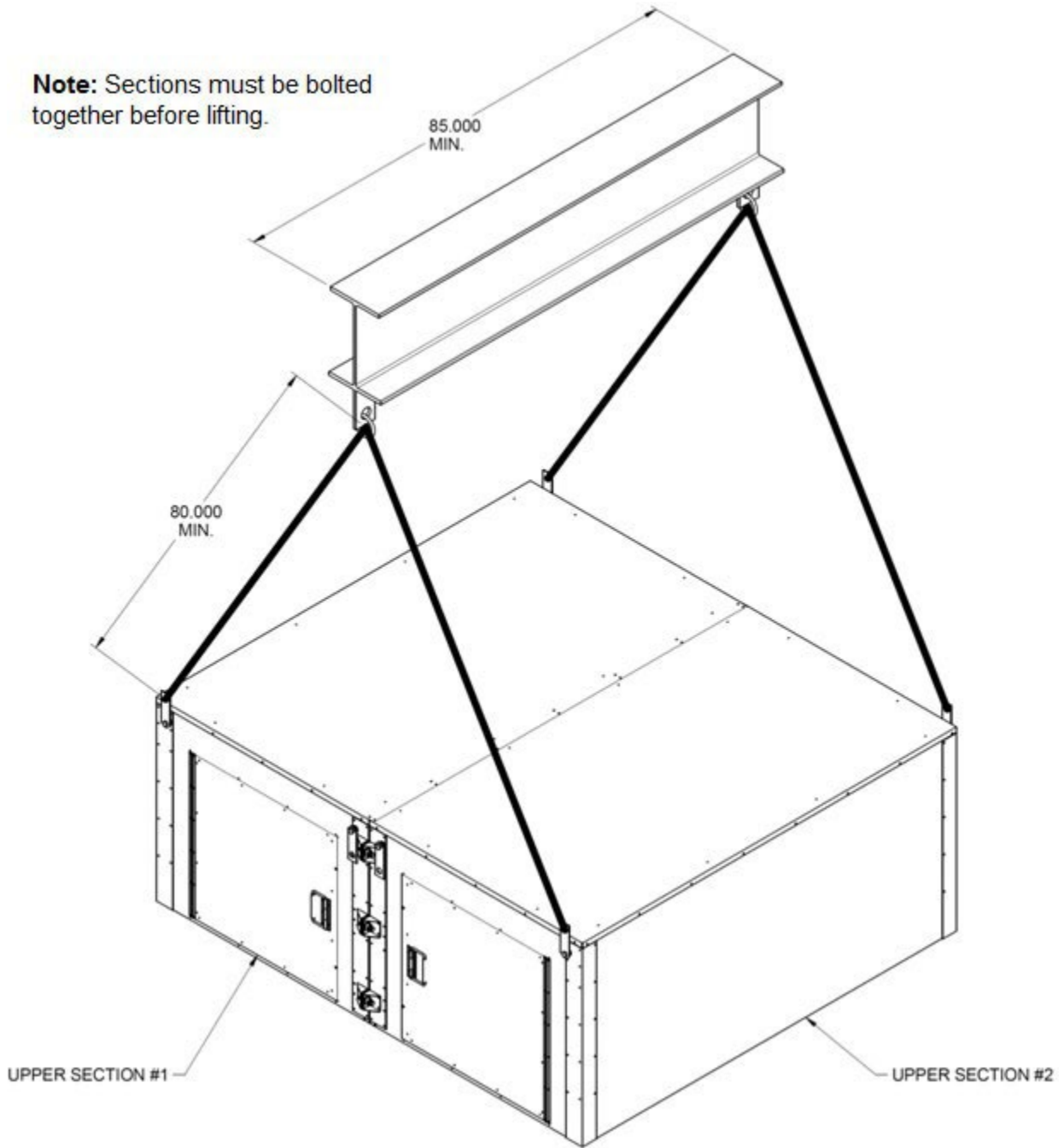

Figure 7 - Two Piece Dual Unit Fan Section Lifting Details

## Split Unit Assembly

Units may be split into modules for shipping. Fan and coil modules must be bolted together and factory provided splices must be installed before operation of the unit.

Split units will also require electrical connection between the modules and individual units after assembly. See Electrical Installation section and unit specific wiring diagrams, within the unit control compartment, for details.

### *Assembly*

1. Remove all shipping covers prior to assembly of modules.
2. Move the coil section to the required location. See Figure 8.
3. For dual units (45-70 tons), move the second coil section close to the first coil section and align the bolt holes of the coil sections. Compressor and control service access doors of each section should be on the same side of the complete unit. A crow-bar or similar tool can be used to line up the sections. Factory provided bolts can then be used

to secure the coil sections together. See Figure 9.

4. Align and set each fan section on top of the coil section(s).
5. For dual units, align the bolt holes of the fan sections, if they are shipped separated. Fan service access doors of each section should be on the same side of the complete unit. A crow-bar or similar tool can be used to line up the sections. Factory provided bolts can then be used to secure the fan sections together. See Figure 9.
6. For dual units, install horizontal, vertical and top splices, overlapping the fan and coil sections. Fasten splices with self-tapping #10 hex head screws. See Figure 9 and Figure 10. Single units (23-35 tons) do not require these splices. Only corner splices are required for single units.
7. Install corner splices, overlapping the fan and coil sections. Fasten splices with self-tapping #10 hex head screws. See Figure 9 and Figure 10.

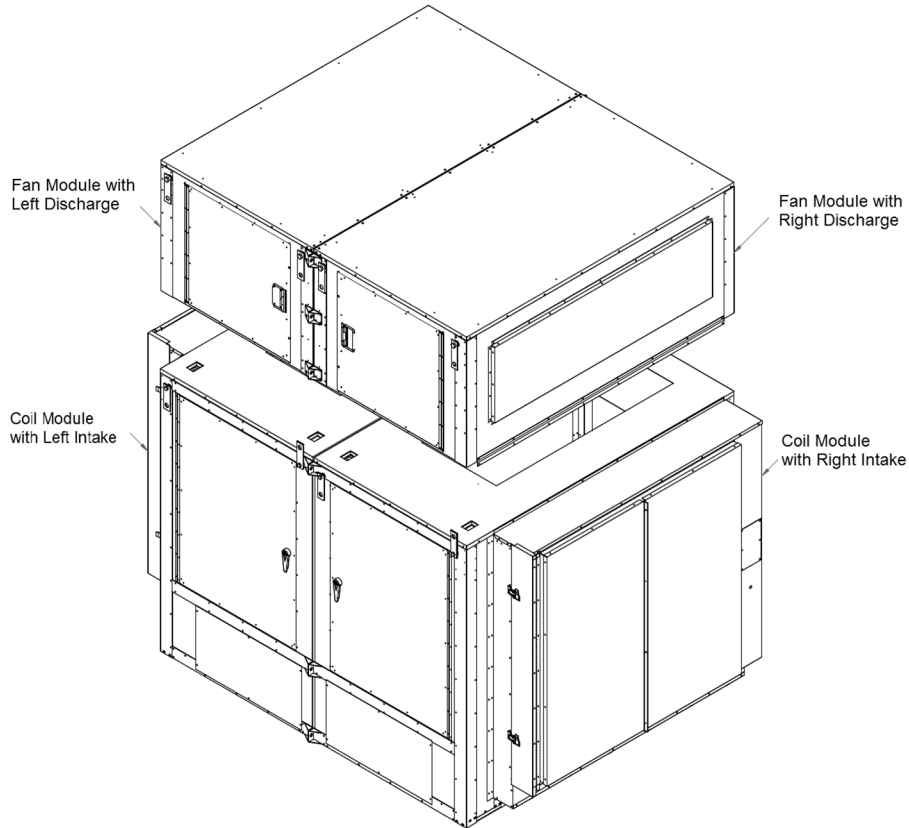

Figure 8- Dual unit without splices and before being bolted together.

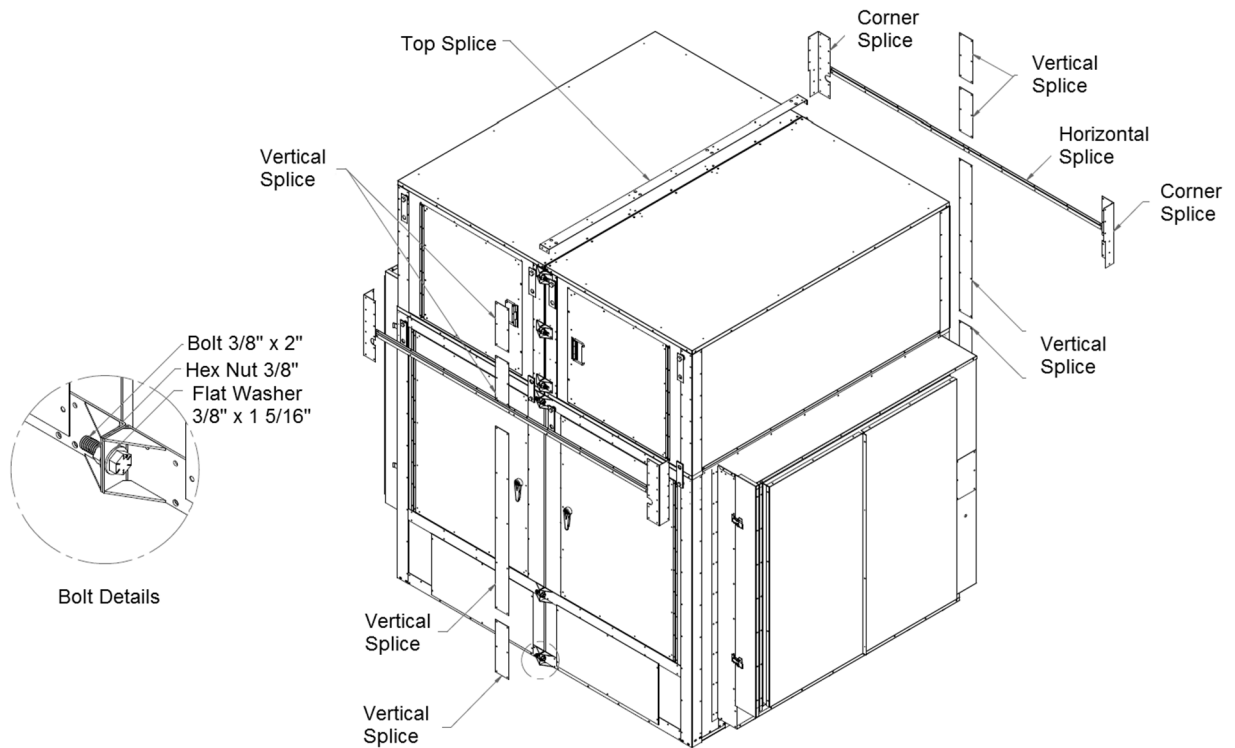

Figure 9 - Dual Unit Assembly Details

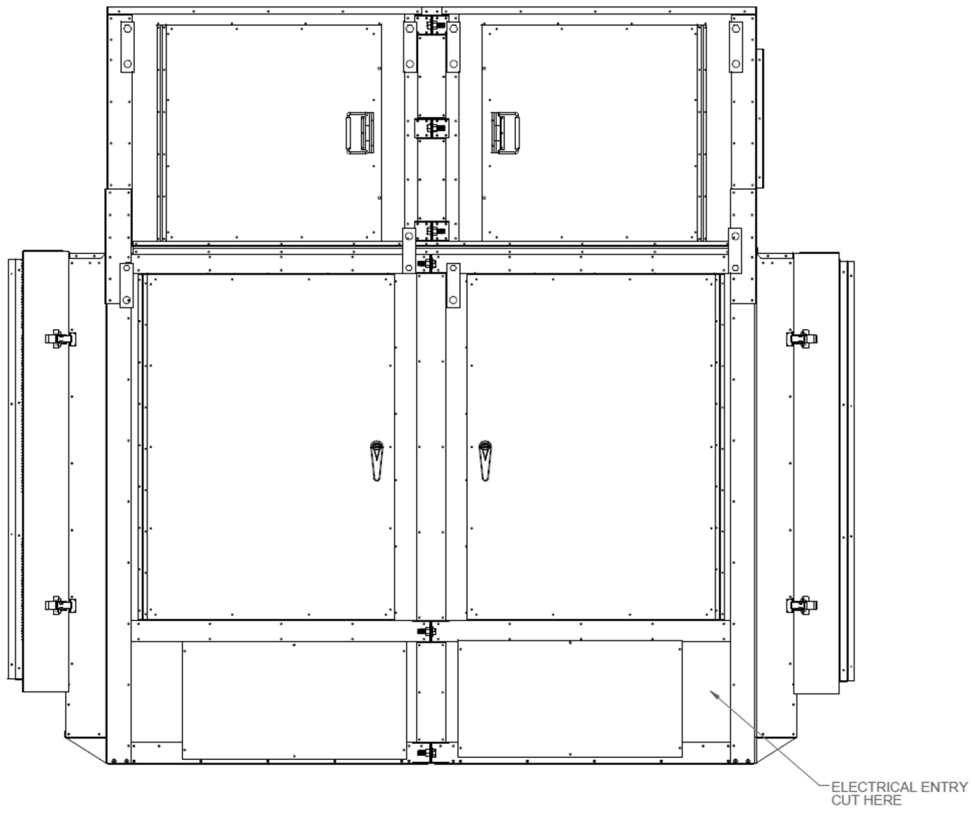

Figure 10 - Dual unit with splices after being bolted together.



## Refrigerant-to-Water Heat Exchanger

Condenser water pump, condenser water piping, cooling tower, pressure gauges, strainers, piping insulation and all components of the waterside piping must be field installed.

### *Open Loop Applications*

This product contains one or more refrigerant-to-water heat exchangers made of 316 Stainless Steel. 316 Stainless Steel is subject to severe corrosion and failure when exposed to chlorides.

 **WARNING**

**OPEN LOOP APPLICATIONS**

Failure of the condenser as a result of chemical corrosion is excluded from coverage under AAON Inc. warranties and the heat exchanger manufacturer's warranties.

Do not allow water containing any form of chlorides to enter this heat exchanger.

Common forms of chlorides include:

1. Sea water mist entering an open cooling tower system.
2. Contaminated make-up water containing salt water.
3. Disinfection to the water loop with solutions containing sodium hypochlorite.

Chlorides will result in a premature failure of the condenser.

Failure of the condenser as a result of chemical corrosion is excluded from coverage under AAON warranties and the heat exchanger manufacturer warranties.

Failure of the condenser will allow water to enter the refrigerant circuit and will cause extensive damage to the refrigerant circuit components. Any damage to the equipment as a result of condenser failure from chemical corrosion due the fluid in the condenser is excluded from coverage under AAON warranties and the heat exchanger manufacturer warranties.

 **WARNING**

**OPEN LOOP APPLICATIONS**

SMO 254 brazed plated refrigerant-to-water heat exchangers are recommended with all open loop applications. Failure to use a SMO 254 heat exchanger may result in premature failure of your system and possible voiding of the warranty.

 **CAUTION**

Cleaning the cooling tower or condenser water loop with harsh chemicals such as hydrochloric acid (muriatic acid), chlorine or other chlorides, can damage the refrigerant-to-water heat exchanger. Care should be taken to avoid allowing chemicals to enter the refrigerant-to-water heat exchanger. See Appendix A - Heat Exchanger Corrosion Resistance for more information

### *Freezing Water in the Heat Exchanger*

This product contains one or more refrigerant-to-water heat exchangers. A refrigerant-to-water heat exchanger contains refrigerant in one passage and water in another passage. Water is subject to freezing

at 0°C (32°F). When water freezes in a heat exchanger significant forces are exerted on the components of the heat exchanger where the water is confined.

Failure of the condenser due to freezing will allow water to enter the refrigerant circuit and will cause extensive damage to the refrigerant circuit components. Any damage to the equipment as a result of water freezing in the condenser is excluded from coverage under AAON warranties and the heat exchanger manufacturer warranties.

|   |
|---|
|  <b>WARNING</b>  |
| <b>WATER FREEZING</b>   |
| <p>Failure of the condenser due to freezing will allow water to enter the refrigerant circuit and will cause extensive damage to the refrigerant circuit components. Any damage to the equipment as a result of water freezing in the condenser is excluded from coverage under AAON warranties and the heat exchanger manufacturer warranties.</p> |

Unit is capable of operating with Entering Water Temperatures (EWT) as low as 13.9°C (57°F), during the cooling mode, without the need for head pressure control. If the EWT is expected to be lower than 13.9°C (57°F) or more stable operation is desired, a factory provided head pressure control water valve option is available.

Glycol solution should be used if ambient temperatures are expected to fall below freezing or if the loop entering water temperature to the unit is below 10°C (50°F) while operating in the heating mode (heat pump units only). Adding glycol to condenser water causes an increase in pressure drop

and also results in a decrease in unit performance. A minimum concentration of 20% glycol solution is recommended.

Table 2- Glycol Freezing Points (Metric)

| % Glycol | Ethylene Glycol | Propylene Glycol |
|----------|-----------------|------------------|
| 20       | -7.8°C          | -7.2°C           |
| 30       | -13.9°C         | -12.8°C          |
| 40       | -21.7°C         | -21.1°C          |
| 50       | -33.3°C         | -32.8°C          |

Table 3 Glycol Freezing Points (Imperial)

| % Glycol | Ethylene Glycol | Propylene Glycol |
|----------|-----------------|------------------|
| 20       | 18°F            | 19°F             |
| 30       | 7°F             | 9°F              |
| 40       | -7°F            | -6°F             |
| 50       | -28°F           | -27°F            |

Water loop piping runs through unheated areas or outside the building should be insulated.

**Water Piping**

Installing contractor must ensure a differential pressure switch or water flow switch is installed between the condenser water supply and return connections. This sensor provides a signal to the unit controller that water flow is present in the refrigerant-to-water heat exchanger and the unit can operate without damaging unit components.

|   |
|---|
|  <b>WARNING</b>   |
| <b>WATER PRESSURE</b>   |
| <p>Prior to connection of condensing water supply, verify water pressure is less than maximum pressure shown on unit nameplate. To prevent injury or death due to instantaneous release of high pressure water, relief valves should be field supplied on water piping. Supply water connection may require a backflow preventer to prevent supply makeup water from backing up into the public water system.</p> |

Table 4 - Condenser Water Connections

| Model (SA-)                                 | Supply and Return Connection Size |
|---|-----------------------------------|
| 023, 045                                    | 3.8 cm (1 1/2") MPT               |
| 028, 030, 035, 050, 055, 058, 060, 065, 070 | 5 cm (2") MPT                     |

Only use approved water pipe material. Avoid using galvanized material for water lines/fittings as the material is corrosive and may cause fouling of the water system.

**! CAUTION**

PVC (Polyvinyl Chloride) and CPVC (Chlorinated Polyvinyl Chloride) are vulnerable to attack by certain chemicals. Polyolester (POE) oils used with R-410A and other refrigerants, even in trace amounts, in a PVC or CPVC piping system will result in stress cracking of the piping and fittings and complete piping system failure.

Condenser water pump must be field sized and installed between the cooling tower and self contained unit. System should be sized in accordance with the ASHRAE Handbook. Use engineering guidelines to maintain equal distances for supply and return piping and limit bend radiuses to maintain balance in the system. Balancing valves, permanent thermometers and gauges may be required.

**! CAUTION**

**WATER PIPING**

Follow national and local codes when installing water piping. Connections to the unit should incorporate vibration eliminators to reduce noise and vibration and shutoff valves to facilitate servicing. Supply and return water piping must be at least as large as the unit connections and larger depending on length of runs, rise and bends.

Before connection to the unit, the condenser water system should be flushed to remove foreign material that could cause condenser fouling. A screen strainer with a minimum of 20 Mesh is provided ahead of the condenser inlet to prevent condenser fouling and internal tube damage.

Mineral content of the condenser water must be controlled. All make-up water has minerals in it and as the water is evaporated in the cooling tower, these minerals remain. As the mineral content of the water increases, the conductivity of the water increases.

Field provided and installed water treatment program must be compatible with stainless steel, copper, aluminum, ABS plastic, and PVC. Batch feed processes should never be used as concentrated chemicals can cause corrosion. Never use hydrochloric acid (muriatic acid) or chlorine as it will corrode stainless steel.

**! CAUTION**

Each heat exchanger may be equipped with a refrigerant pressure relief device to relieve pressure should excessive condensing pressures 4.654 Mpa (>675 psig) occur. Codes may require installing contractor to connect and route relief piping outdoors. The relief valve has a 1.6 cm (5/8") male flare outlet connection.

**NOTE:** Ball valves should be installed in the condenser water supply and return lines for unit isolation and water flow balancing. All manual flow valves should be of the ball valve design. Globe or gate valves should not be used due to high pressure drops and poor throttling characteristics.

Pressure and temperature ports are recommended in condenser water supply and return lines for system balancing. These openings should be 5 to 10 pipe diameters from the unit water connections. To allow for mixing and temperature stabilization, wells in the water piping should extend at least ½ pipe diameter into the pipe.

**! CAUTION**

Installing contractor is responsible for properly sizing and installing water system components. Improper fluid flow due to valves, piping, or improper pump operation may result in unacceptable unit operation and void warranty.

Table 5 - Condenser Pressure Drops (Each Heat Exchanger)

| SA- 023    |            | SA-028     |            | SA-030     |            | SA-035     |            |
|------------|------------|------------|------------|------------|------------|------------|------------|
| LPM (GPM)  | KPA (PSI)  | LPM (GPM)  | KPA (PSI)  | LPM (GPM)  | KPA (PSI)  | LPM (GPM)  | KPA (PSI)  |
| 170.6 (45) | 29 (4.2)   | 170.6 (45) | 29 (4.2)   | 170.6 (45) | 29 (4.2)   | 170.6 (45) | 1.7 (11.7) |
| 147.8 (39) | 22.8 (3.3) | 147.8 (39) | 22.8 (3.3) | 147.8 (39) | 22.8 (3.3) | 147.8 (39) |            |
| 132.7 (35) | 19.3 (2.8) | 132.7 (35) | 19.3 (2.8) | 132.7 (35) | 19.3 (2.8) | 132.7 (35) |            |

| SA -045    |            | SA-050     |            | SA-055     |            | SA-058     |            |
|------------|------------|------------|------------|------------|------------|------------|------------|
| LPM (GPM)  | KPA (PSI)  | LPM (GPM)  | KPA (PSI)  | LPM (GPM)  | KPA (PSI)  | LPM (GPM)  | KPA (PSI)  |
| 170.6 (45) | 29 (4.2)   | 170.6 (45) | 29 (4.2)   | 170.6 (45) | 29 (4.2)   | 170.6 (45) | 29 (4.2)   |
| 147.8 (39) | 22.8 (3.3) | 147.8 (39) | 22.8 (3.3) | 147.8 (39) | 22.8 (3.3) | 147.8 (39) | 22.8 (3.3) |
| 132.7 (35) | 19.3 (2.8) | 132.7 (35) | 19.3 (2.8) | 132.7 (35) | 19.3 (2.8) | 132.7 (35) | 19.3 (2.8) |

| SA -060       |              | SA-065           |              |                  |               | SA-070        |               |
|---------------|--------------|------------------|--------------|------------------|---------------|---------------|---------------|
|               |              | Heat Exchanger 1 |              | Heat Exchanger 2 |               |               |               |
| LPM<br>(GPM)  | KPA<br>(PSI) | LPM<br>(GPM)     | KPA<br>(PSI) | LPM<br>(GPM)     | KPA<br>(PSI)  | LPM<br>(GPM)  | KPA<br>(PSI)  |
| 170.6<br>(45) | 29 (4.2)     | 170.6<br>(45)    | 29 (4.2)     | 170.6<br>(45)    | 1.7<br>(11.7) | 170.6<br>(45) | 1.7<br>(11.7) |
| 147.8<br>(39) | 22.8 (3.3)   | 147.8<br>(39)    | 22.8 (3.3)   | 147.8<br>(39)    |               | 147.8<br>(39) |               |
| 132.7<br>(35) | 19.3 (2.8)   | 132.7<br>(35)    | 19.3 (2.8)   | 132.7<br>(35)    |               | 132.7<br>(35) |               |

 **CAUTION**

Do not exceed recommended condenser fluid flow rates shown in above table. Serious damage to or erosion of the heat exchanger tubes could occur.

Piping systems should not exceed 3.1 m/s (10 ft/sec) fluid velocity to ensure tube wall integrity and reduce noise.

***Brazed Plate Heat Exchanger Cleaning***

Because of a normally high degree of turbulence in brazed plate heat exchangers, for many applications the heat exchanger channels are self cleaning. For applications that are not self cleaning (i.e. hard water at high temperatures, etc.) or applications where additional cleaning is desired, it is possible to clean the brazed plate heat exchanger by circulating a cleaning liquid.

Use a tank with weak acid, 5% phosphoric acid (H<sub>3</sub>PO<sub>4</sub>) or, if the exchanger is frequently cleaned, 5% oxalic acid (H<sub>2</sub>C<sub>2</sub>O<sub>4</sub>). Pump the cleaning liquid through the exchanger. For optimum cleaning, the cleaning solution flow rate should be a minimum of 1.5 times the normal flow rate, preferably in a back-flush mode. After cleaning, the heat exchanger must be rinsed with clean water. A solution of 1-2% sodium hydroxide (NaOH) or sodium bicarbonate (NaHCO) before the last rinse ensures that all acid is neutralized.

**Electrical**

Verify the unit name plate agrees with power supply. SA Series units are provided with single point power wiring connections. Connection terminations are made to the main terminal block. A complete set of unit specific wiring diagrams, showing factory and field wiring are laminated in plastic and

located inside the controls compartment door.

 **WARNING**

Disconnect all electrical power sources before servicing the unit. More than one power source may be provided. Failure to do so may result in injury or death from electrical shock or entanglement in moving parts.

All units require field supplied electrical overcurrent and short circuit protection. Device must not be sized larger than the Maximum Overcurrent Protection (MOP) shown on the unit nameplate.

Codes may require a disconnect switch be within sight of the unit.

It is recommended that the field installed overcurrent protection or disconnect switch not be installed on the unit.

Electrical supply can enter through the bottom or side of the controls compartment. Entry must be field cut into panels of the unit.

A single point connection to a terminal block is provided. Split units may require connection between the units. High voltage conductors should enter the control panel in a separate opening and separate conduit than 24V low voltage conductors.

 **WARNING**

The foam insulation releases dangerous fumes when it is burnt. Do not cut a foam part with a cutting torch or plasma cutter. Do not weld to a foam filled part.

**Note:** Locations for field cut electrical entries are marked on the unit. Field cut openings must be a minimum of 15.25 centimeters (6 inches) away from all components and wiring to prevent damage due to drilling or cutting.

To pass wires through the wall or roof of the unit, a hole should be cut and conduit passed through it. Use the following procedure to cut a round hole in a foam panel.

### ***Cutting Electrical Openings***

1. Locate the placement of the hole. Be sure that the conduit will not interfere with the operation of any component or prevent access of any door or removable panel.
2. Drill a pilot hole all the way through the foam panel.
3. Using a hole saw cut the hole through the metal on both sides of the foam part.
4. With a knife cut the foam out of the hole.
5. After the conduit is installed in the hole caulk the entire perimeter of the hole on both sides with an industrial grade silicone sealant or a duct seal compound.

If a larger cut-out is needed for additional duct connections not provided by the factory, or for any other reason, it is very important that the foam be completely sealed. Insulation covers should be fabricated from sheet metal to cover the foam at the cut. The edges and corners that are not covered should then be sealed using silicone caulking or a duct seal compound.

If a reciprocating saw is used to make the cut-out take care that the metal skins of the foam part do not separate from the foam, this would result in reduced structural integrity of the part.

Size supply conductors based on the unit Minimum Current Ampacity (MCA) rating. Supply conductors must be rated a minimum of 75°C (167°F).

Protect the branch circuit in accordance with code requirements. The unit must be electrically grounded in accordance with local codes, or in the absence of local codes, the current National Electric Code, ANSI/NFPA 70 or the current Canadian Electrical Code CSA C22.1.

**Note:** All units are factory wired for 208/230V, 460V, or 575V. If unit is to be connected to a 208V supply, the transformer must be rewired to 208V service. For 208V service interchange the yellow and red conductor on the low voltage control transformer.

Red-Black for 208V  
Yellow-Black for 230V

Wire power leads to the unit's terminal block or main disconnect. All wiring beyond this point has been completed by AAON and cannot be modified without effecting the unit's agency/safety certification.

Supply voltage must be within the min/max range shown on the unit nameplate. Available short circuit current should not exceed the short circuit current rating (SCCR) shown on the unit nameplate.

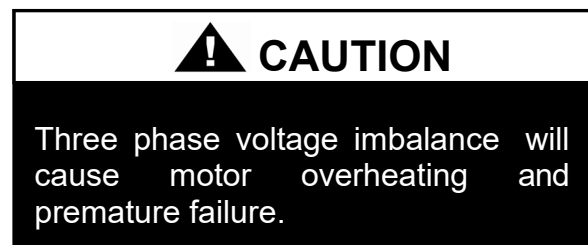

Three phase voltage imbalance will cause motor overheating and premature failure. The maximum allowable imbalance is 2.0%.

Voltage imbalance is defined as 100 times the maximum deviation from the average voltage divided by the average voltage.

Example:

$(221V+230V+227V)/3 = 226V$ , then  
 $100*(226V-221V)/226V = 2.2\%$ , which exceeds the allowable imbalance.

Check voltage imbalance at the unit disconnect switch and at the compressor terminal. Contact your local power company for line voltage corrections.

Installing contractor must check for proper motor rotation and check blower motor amperage listed on the motor nameplate is not exceeded. Motor overload protection may be a function of the variable frequency drive (VFD) and must not be bypassed.

|  |
|--|
|  <b>CAUTION</b>   |
| Rotation must be checked on all <b>MOTORS AND COMPRESSORS</b> of three phase units. Supply fan motors should all be checked by a qualified service technician at startup and any wiring alteration should only be made at the unit power connection. |

|  |
|--|
|  <b>CAUTION</b>   |
| Scroll compressors are directional and will be damaged by operation in the wrong direction. Low pressure switches on compressors have been disconnected after factory testing. Rotation should be checked by a qualified service technician at startup using suction and discharge pressure gauges and any wiring alteration should only be made at the unit power connection. |

Wire control signals to the unit's low voltage terminal block located in the controls compartment.

If any factory installed wiring must be replaced, use a minimum 105°C (221°F) type AWM insulated conductors.

### ***Thermostat Control Wiring***

If a thermostat is used for unit control, thermostat should be located on an inside wall 4-5 feet above the floor where it will not be subjected to drafts, sun exposure, or heat from electrical fixtures or appliances. Control wiring must deliver adequate voltage to components to assure proper operation. Control voltage returning from controller circuit must be a minimum of 21 VAC. To assure proper wiring use the following chart to determine the allowable wiring distances.

Table 6 - Control Wiring

| Wire Size (Stranded)<br>- Copper Conductors<br>Only | Total Wire Distance<br>Allowable |         |
|---|----------------------------------|---------|
| 20 AWG  | 60.96 m                          | 200 ft  |
| 18 AWG  | 106.7 m                          | 350 ft  |
| 16 AWG  | 152.4 m                          | 500 ft  |
| 14 AWG  | 228.6 m                          | 750 ft  |
| 12 AWG  | 381.0 m                          | 1250 ft |

Total Wire Distance Allowable =  
(Quantity of Control Wires) x  
(Control Wire Distance)

Take the total wire distance allowable and divide by the number of wires to be connected. This indicates the distance allowable for that size wire. The wiring to the unit must not exceed the total wire distance allowable. If the voltage at the connectors is less than 21 VAC, isolation relays must be installed. If under external control 21 VAC must be field verified.

All external devices must be powered via a separate external power supply.



Example:

A total of 8 wires must be pulled 22.9 m (75ft) to a control the unit. What size wire should be used?

According to the Table 5, 16 AWG allows for 63ft (500 ft/8 wires) and 14 AWG allows for 94ft (750 ft/8 wires). Thus, 14 AWG should be used.

**Fuses and Circuit Breakers**

The interrupting rating of fuses and circuit breakers is to be determined based on the KAIC rating of the unit. Refer to the wiring diagram for fuse sizing.

Table 7 – 35 KAIC Fuse Sizing

| 35 KAIC Construction |                            |                          |
|----------------------|----------------------------|--------------------------|
| Component            | Description                | Interrupting Rating (kA) |
| Fuse                 | Class CC, 600V, 0.5A - 30A | 200                      |
| Fuse                 | Class J, 600V, 35A - 600A  | 200                      |
| Disconnect           | 3P, 600V, 15A - 600A       | 35                       |

Table 8 – 65 KAIC Fuse Sizing

| 65 KAIC Construction |                            |                          |
|----------------------|----------------------------|--------------------------|
| Component            | Description                | Interrupting Rating (kA) |
| Fuse                 | Class CC, 600V, 0.5A - 30A | 200                      |
| Fuse                 | Class J, 600V, 35A - 600A  | 200                      |
| Disconnect           | 3P, 600V, 15A - 600A       | 65                       |

**Duct Connection**

Return air enters the either the left, right or both the left and right sides of the unit, where the air filters are located. Ductwork should be sized in accordance with the ASHRAE Handbook. Ductwork should be installed in accordance with NFPA Standard 90A.

When attaching duct to the unit, use a flexible/compressible material rated for duct connections. A 1.2 centimeter (3 inch) flexible connector for both return and supply duct connections is recommended.

Supply air duct connection can be on the left, right, back, or top sides of the supply fan plenum. See unit drawing for more information.

Table 9 - Duct Connection Sizes (Metric)

| Location             | Model (SA-) |               |
|----------------------|-------------|---------------|
|                      | 023-025 (m) | 045-070 (m)   |
| Top                  | 0.8 x 1.6   | (2) 0.8 x 1.6 |
| Back                 | 0.5 x 0.8   | (2) 0.5 x 0.8 |
| Side (Right or Left) | 0.5 x 1.6   | (2) 0.5 x 1.6 |

Table 10 - Duct Connection Sizes (Imperial)

| Location             | Model (SA-) |               |
|----------------------|-------------|---------------|
|                      | 023-025     | 045-070       |
| Top                  | 30" x 64"   | (2) 30" x 64" |
| Back                 | 19" x 30"   | (2) 19" x 30" |
| Side (Right or Left) | 19" x 64"   | (2) 19" x 64" |

**Condensate Drain Piping**

Unit may be equipped with more than one condensate drain pan connection. A p-trap and drain line must be installed on every drain connection, with the p-trap not to exceed 15.24 cm (6") from the drain connection. The lines should be the same pipe size or larger than the drain connection, include a p-trap, and pitch downward toward drain. An air break should be used with long runs of condensate lines.

Draw-through cooling coils will have a negative static pressure in the drain pan area. This will cause an un-trapped drain to back up due to air being pulled up through the condensate drain piping.

Condensate drain trapping and piping should conform to all applicable governing codes.

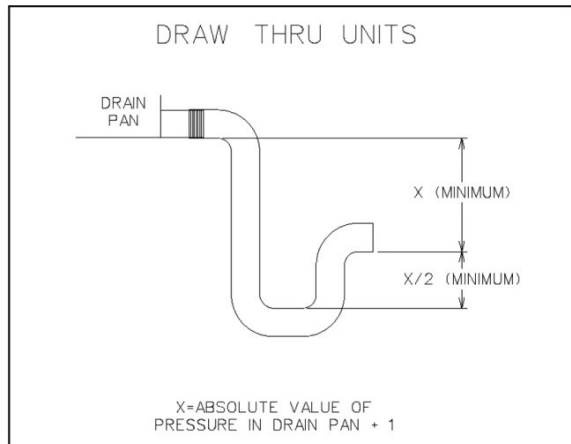

Figure 11 - Drain Trap

**Note:** The drain pan connection is a 2.5 cm (1”) MPT fitting.

The X dimension on the draw-through trap should be at least equal to the absolute value of the negative static pressure in the drain pan plus one inch. To calculate the static pressure at the drain pan add the pressure drops of all components upstream of the drain pan, including the cooling coil, and add the return duct static pressure. Include

the dirt allowance pressure drop for the filters to account for the worst-case scenario.

The height from top of the bottom bend of the trap to the bottom of the leaving pipe must be at least equal to one half of the X dimension. This ensures that enough water is stored in the trap to prevent losing the drain seal during unit startup.

**! CAUTION**

Unit should not be operated without p-traps. Failure to install a p-traps may result in overflow of condensate water.

**Note:** The absolute value of the fan inlet pressure will always be greater than or equal to the absolute value of the static pressure in the drain pan on draw-through units, so the fan inlet pressure is a safe value to use for the drain pan static pressure.

Table 11 - Drain Trap Dimensions (Metric)

| Draw-Through       |                 |      |
|--------------------|-----------------|------|
| Drain Pan Pressure | Trap Dimensions |      |
| Negative Static    | X               | X/2  |
| (mm of mercury)    | (mm)            | (mm) |
| -0.93              | 12.70           | 6.4  |
| -1.87              | 25.40           | 12.7 |
| -2.80              | 38.10           | 19.1 |
| -3.74              | 50.80           | 25.4 |
| -4.67              | 63.50           | 31.8 |
| -5.60              | 76.20           | 38.1 |
| -6.54              | 88.90           | 44.5 |
| -7.47              | 101.60          | 50.8 |

Table 12 - Drain Trap Dimensions (Imperial)

| Draw-Through       |                 |        |
|--------------------|-----------------|--------|
| Drain Pan Pressure | Trap Dimensions |        |
| Negative Static    | X               | X/2    |
| (inches of water)  | (inch)          | (inch) |
| -0.50              | 1.50            | 0.75   |
| -1.00              | 2.00            | 1.00   |
| -1.50              | 2.50            | 1.25   |
| -2.00              | 3.00            | 1.50   |
| -2.50              | 3.50            | 1.75   |
| -3.00              | 4.00            | 2.00   |
| -3.50              | 4.50            | 2.25   |
| -4.00              | 5.00            | 2.50   |

## **Waterside Economizer**

Cooling and pre-cooling waterside economizer coil is factory installed upstream of the evaporator coil. Factory tested and field installed water piping kit includes fully modulating waterside economizer valve and fully modulating waterside economizer bypass valve.

The waterside economizer circuit can operate in three modes: waterside economizer only, waterside economizer with mechanical cooling, and mechanical cooling only.

During waterside economizer only mode of operation condenser water flows through the waterside economizer coil with modulating valves maintaining supply air temperature setpoint. The condenser water completely bypasses the water-cooled condenser.

During waterside economizer with mechanical cooling mode of operation condenser water flows through the waterside economizer coil with the waterside economizer modulating valve fully open. The condenser water then passes through water-cooled condenser.

During mechanical cooling only mode of operation condenser water flows around the waterside economizer coil with the waterside economizer bypass valve fully open. The condenser water then passes through water-cooled condenser.

Waterside economizer coil condensate drain outlet drains into evaporator coil drain pan. See the previous section on evaporator coil condensate drain piping.

Mineral content of the condenser water must be controlled. All make-up water has minerals in it and as the water is evaporated in the cooling tower, these minerals remain. As the mineral content of the water increases, the conductivity of the water increases.

Field provided and installed water treatment program must be compatible with stainless steel, copper, aluminum, ABS plastic, and PVC. Batch feed processes should never be used as concentrated chemicals can cause corrosion. Never use hydrochloric acid (muriatic acid) or chlorine as it will corrode stainless steel.

*Waterside Economizer Piping Kit*

**! CAUTION**

A qualified technician is responsible for properly sizing and installing water system components. Improper fluid flow due to valves, piping, or improper pump operation may result in unacceptable unit operation and void warranty.

For single cabinet units connect the three factory provided piping assemblies. For dual cabinet units connect both sets of factory provided piping assemblies.

Connect the piping assembly to the unit.

Connect the actuators to the water valves. Actuators are factory wired and included inside the unit.



Figure 12 - SA Series Unit with Waterside Economizer Piping

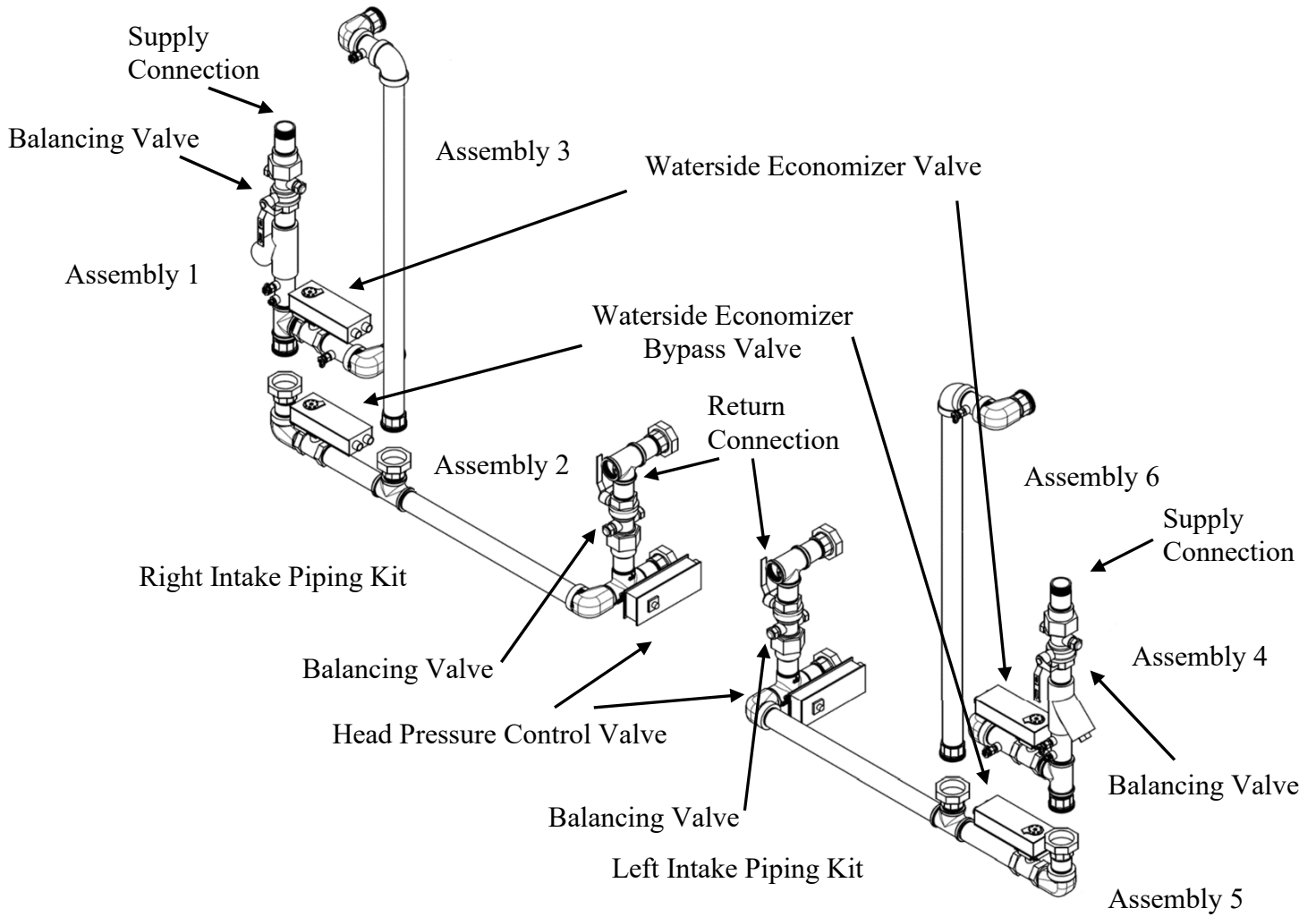

Figure 13 - Air Conditioner Waterside Economizer Piping Kit

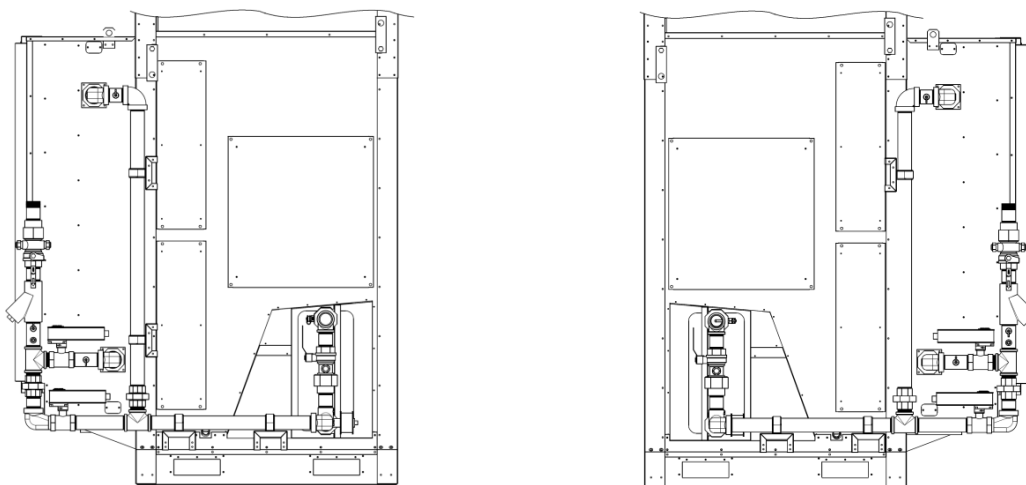

Figure 14 - Air Conditioner Waterside Economizer Back View

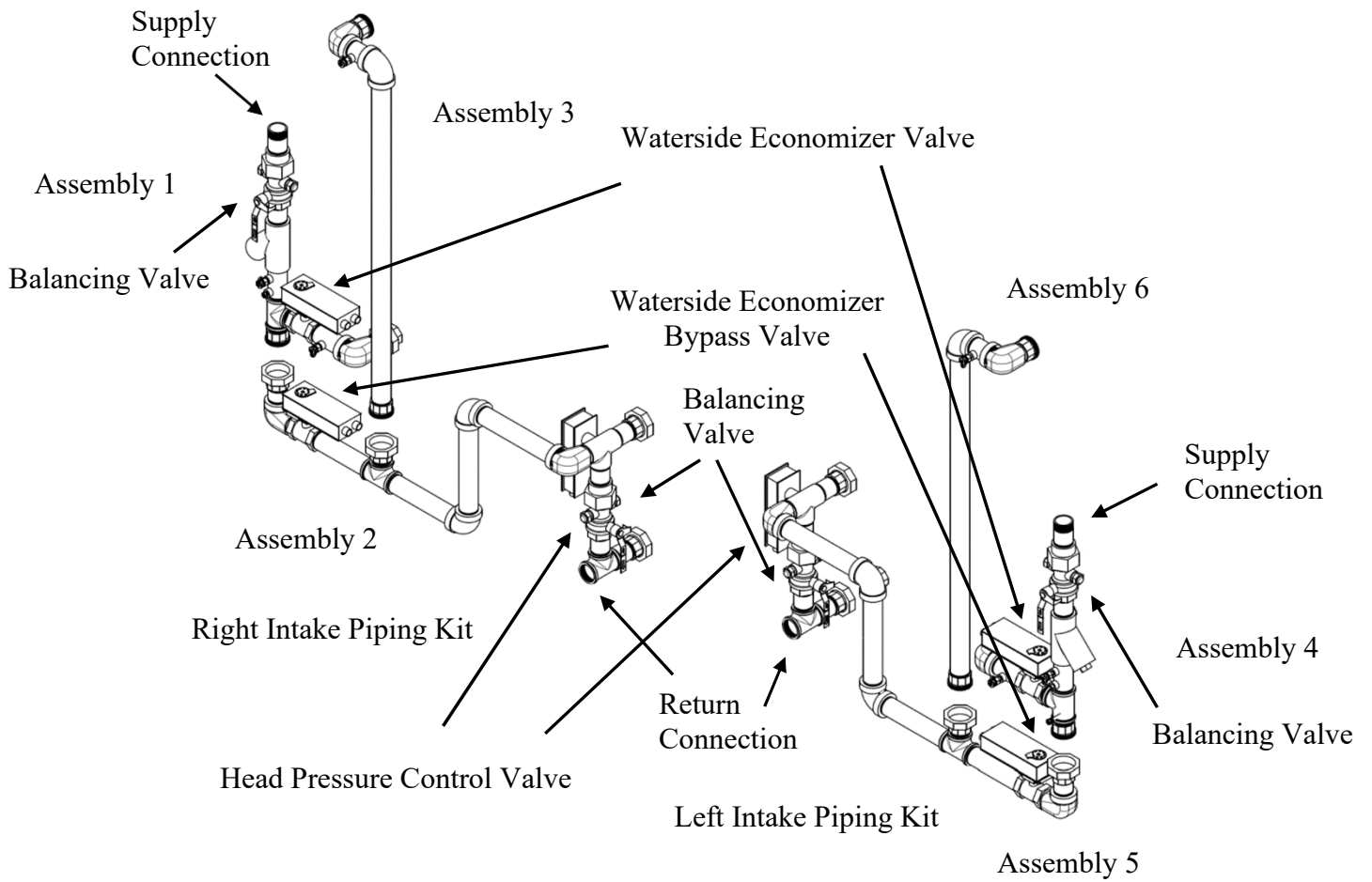

Figure 15 - Water-Source Heat Pump Waterside Economizer Piping Kit

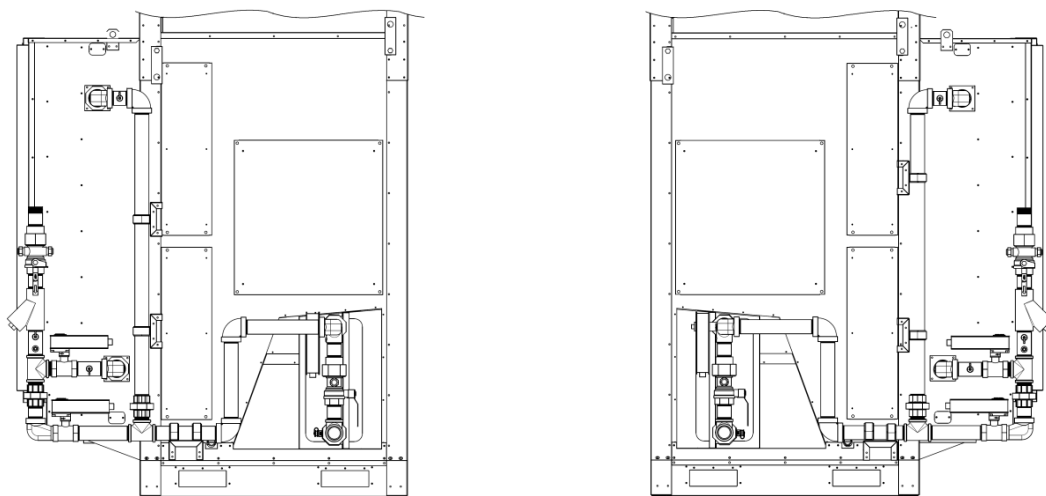

Figure 16 - Water-Source Heat Pump Waterside Economizer Back View

### Hot Water Coil

Factory installed one or two row hot water heating coils can be factory mounted. These coils are supplied from a hot water source through separate piping from the condenser water source. All controls for heating operation are field supplied and field installed.

Always connect the supply to the top of the coil and the return to the bottom. Water coils should not be subjected to entering air temperatures below 3.3° (38°F) to prevent coil freeze-up. If air temperature across the coil is going to be below this value, use a glycol solution to match the coldest air expected.

### Chilled Water Coil

Factory installed four or six row chilled water cooling coils can be factory mounted. These coils are supplied from a chilled water source through separate piping from the condenser water source. All controls for the cooling coil are field supplied and field installed.

Connect the chilled water supply to the bottom of the coil and return to the top.

Water supply lines must be insulated with closed cell type pipe insulation or insulation that includes a vapor barrier. Lines must be properly fastened, drained and supported according to local code requirements, and job specifications.

Table 13 -Min and Max Water Pressure and Temps

|                     | Chilled Water      | Hot Water      |
|---------------------|--------------------|----------------|
| Min. Entering Air   | 15.6°C (60°F)      | 4.4 °C (40°F)  |
| Max Entering Air    | 37.8°C (100°F)     | 26.7°C (80°F)  |
| Min. Entering Water | 1.7°C (35°F)       | 60°C (140°F)   |
| Max Entering Water  | 18.3°C (65°F)      | 93.3°C (200°F) |
| Min. Water Pressure | 0 kpa (15 psig)    |                |
| Max Water Pressure  | 2068kpa (300 psig) |                |

## Startup

(See back of the manual for startup form)

### WARNING

Piping shall be in accordance with national and local codes. Pressure limiting devices, backflow preventers and all other safety requirements are the sole responsibility of the installing contractor.

### WARNING

Improper installation, adjustment, alteration, service or maintenance can cause property damage, personal injury or loss of life. Startup and service must be performed by a Factory Trained Service Technician. A copy of this IOM should be kept with the unit.

During startup, it is necessary to perform routine checks on the performance of the unit. This includes checking of the air flow, the air filters, condenser water flow and refrigerant charge.

### Filters

Do not operate the unit without filters in place. Operation of the equipment without filters in place can result in clogged coils. Units are shipped with the selected filters installed. If filters have been removed during installation, open the filter access door and re-install the correct filters with the airflow indicator arrows pointing in the direction of airflow.

Check filters after a few days of operation after the unit has been started up as dust and debris from construction may cause premature filter loading. Replace the filters if necessary.

## Supply Fans

SA Series units are equipped with direct drive backward curved plenum supply fan assemblies that deliver the air volume specified according to unit size and job requirements

### Supply Fan Spring Isolator Adjustment

**! CAUTION**

Failure to adjust the blower isolation springs may cause premature failure of the blower bulkhead and/or blower assembly. These damages will not be covered by warranty. Blower isolation springs must be adjusted by installing contractor prior to unit start up. Springs must be adjusted such that the blower assembly is "free floating" and "level".

Fan assemblies are equipped with spring isolators in the fan section for vibration attenuation.

Prior to shipment the isolators are set in the lock down position to protect the unit during transit.

Once the unit is set into place it is important that all of the isolators are adjusted out of the shipping position and the shipping material is discarded before the unit is put into operation.

Remove all six screws from each shipping bracket and discard brackets.

On all four isolators, secure the adjustment bolt and rotate the locking nut counter clockwise approximately four full rotations. This will allow the locking nut to spin when the adjustment bolt is turned (See Figure 17).

Turn adjustment bolt counter-clockwise to adjust all four isolators until 3/4 inch clearance is obtained between all spring brackets and spring supports.

Check all isolators to ensure that the spring, spring cap and spring baseplate are aligned. The position of the spring cap should be adjusted such that the spring is straight up and down. Adjustments can be made by applying horizontal pressure to the locking nut.

Individually tighten all four locking nuts while the adjustment bolts are held in position.

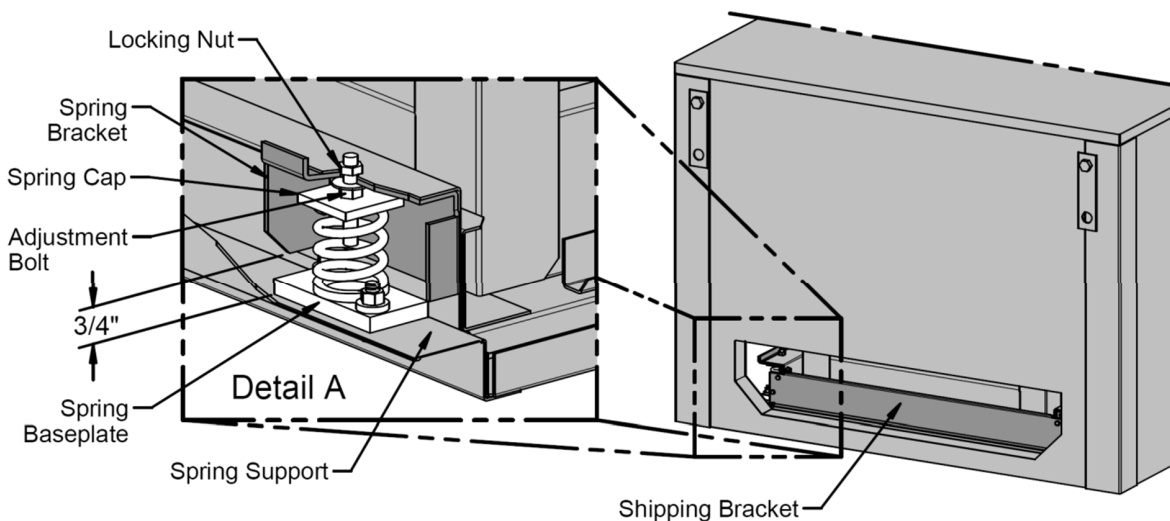

Figure 17 - Spring Isolation



## Supply Fan Removal

**! WARNING**

Disconnect all electrical power sources before servicing the unit. More than one power source may be provided. Failure to do so may result in injury or death from electrical shock or entanglement in moving parts.

1. Disconnect all electrical power sources to the unit.
2. Disconnect the supply fans using the quick connect electrical harness located in the control compartment.
3. Remove the three screws on the hold down bracket on the front side of the fan assembly frame.
4. Remove the back fan access panel and then remove the three screws on the rear side of the fan assembly frame.
5. Slide the complete fan assembly forward through the front supply fan access door.

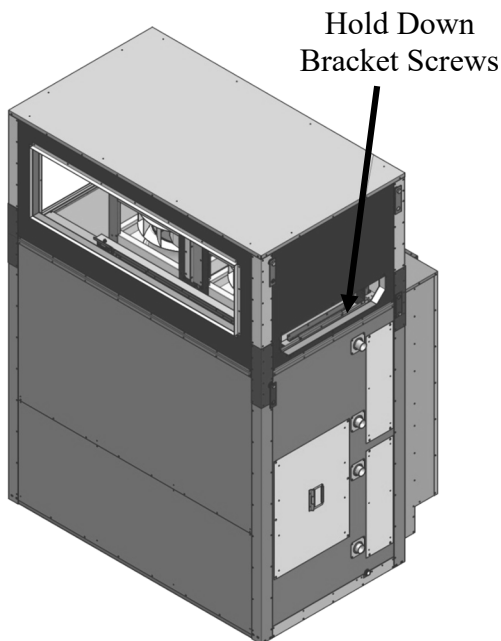

Figure 18 - Back View with Supply Fan Access Panel Removed

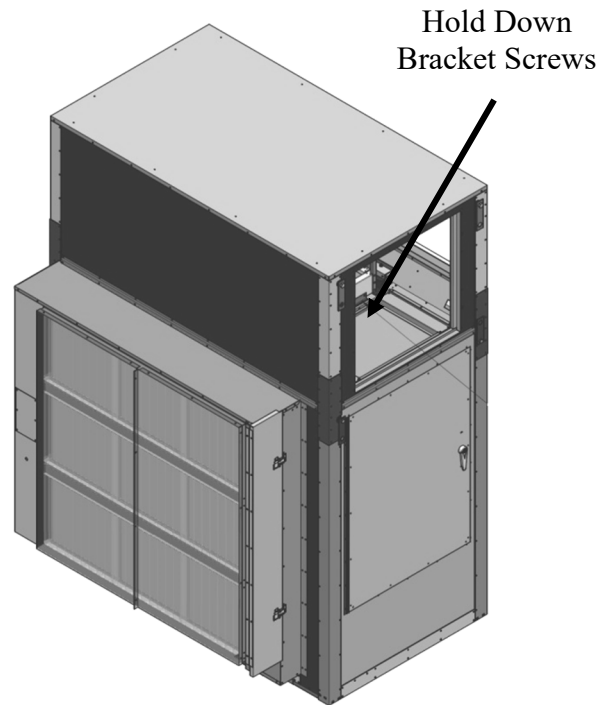

Figure 19 - Front View with Supply Fan Access Door Open

### *Fan Airflow Adjustment*

A specific air volume is delivered by the fans with air volume bands in the blower wheels or with VFDs. Field airflow adjustment may be required at startup.

Air volume bands for the wheels are sized according to the unit's air delivery specifications and can also be ordered from the factory for field installation. Wheels come standard with a 10% air volume band, as a safety factor, in case additional air volume is required from the unit.

### *Adjustment*

If reduced air volume is required an air volume band or larger air volume band can be installed within the blower wheel to reduce the amount of air delivered by the wheel.

If the unit is factory equipped with the air volume band and additional air volume is

required, the band can be removed from the wheel.

Use fan program in AAON Ecat32 to determine the new band size for the required cfm and static pressure.

The following photos of a wheel are provided for practical guidelines only in order to identify the air band location in the wheel. Actual field installation of the air band into the wheel will require access into and through the blower wheel venture, which may require removal of the blower motor and wheel.

Air volume bands are made of aluminum, sized and equipped with easy bend tabs that are to be inserted into pre-punched slots provided on the wheel. Once the band has been inserted into the slots, it MUST BE secured by bending the tabs over from the back side of the wheel and also MUST BE secured from the inside by connecting the ends together with a pop-rivet in the holes provided on the ends of the band.

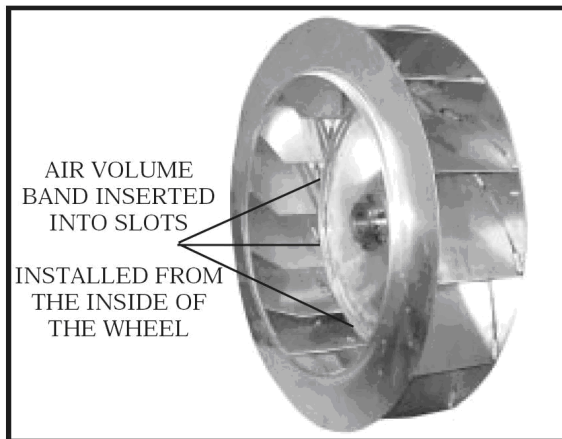

Figure 20 - Blower Wheel with Band

If the band is field installed, a hand-held pop-rivet tool is recommended for connecting the band ends together. Caution must be taken to assure that the band is tightly installed and no damage, denting or

alteration to the wheel or blades occurs during the installation.

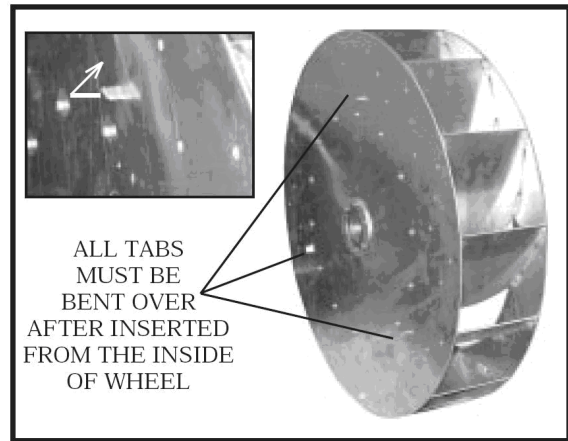

Figure 22 - Band Tabs



Figure 23 - Blower Wheel

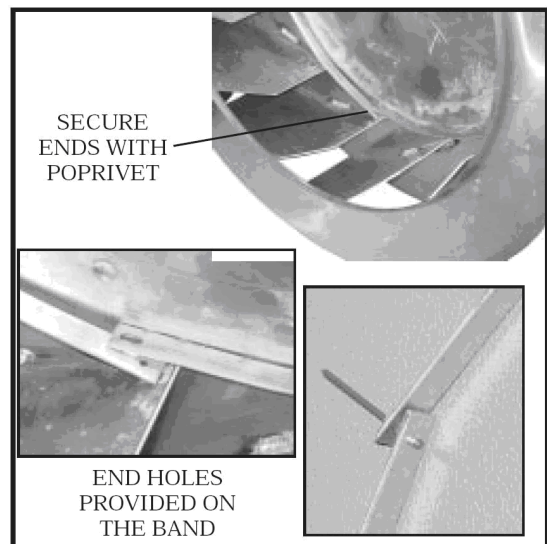

Figure 21 - Securing the Band

**! CAUTION**

Before completing startup and leaving the unit a complete operating cycle should be observed to verify that all components are functioning properly.

**Adjusting Refrigerant Charge**

Adjusting the charge of a system in the field must be based on determination of liquid sub-cooling and evaporator superheat. On a system with a TXV liquid sub-cooling is more representative of the charge than evaporator superheat but both measurements must be taken.

Before Charging

Unit being charged must be at or near full load conditions before adjusting the charge.

Units equipped with hot gas reheat must be charged with the hot gas reheat valves closed while the unit is in cooling mode to get the proper charge. After charging, unit should be operated in reheat (dehumidification) mode to check for correct operation.

Units equipped with heat pump options should be charged in heating mode to get the proper charge. After charging, unit should be operated in cooling mode to check for correct charge. Charge may need to be adjusted for cooling mode. If adjustments are made in the cooling mode, heating mode must be rerun to verify proper operation.

After adding or removing charge the system must be allowed to stabilize, typically 10-15 minutes, before making any other adjustments.

**! CAUTION**

The Clean Air Act of 1990 bans the intentional venting of refrigerant (CFC's and HCFC's) as of July 1, 1992. Approved methods of recovery, recycling or reclaiming must be followed. Fines and/or incarceration may be levied for non-compliance.

The type of unit and options determine the ranges for liquid sub-cooling and evaporator superheat. Refer to the tables below when determining the proper sub-cooling.

Checking Liquid Sub-Cooling

Measure the temperature of the liquid line as it leaves the condenser.

Read the gauge pressure at the liquid line close to the point where the temperature was taken. You must use liquid line pressure as it

will vary from discharge pressure due to condenser pressure drop.

Convert the pressure obtained to a saturated temperature using the appropriate refrigerant temperature-pressure chart.

Subtract the measured liquid line temperature from the saturated temperature to determine the liquid sub-cooling.

Compare calculated sub-cooling to the table below for the appropriate unit type and options.

Checking Evaporator Superheat

Measure the temperature of the suction line close to the compressor.

Read gauge pressure at the suction line close to the compressor.

Convert the pressure obtained to a saturated temperature using the appropriate refrigerant temperature-pressure chart.

Subtract the saturated temperature from the measured suction line temperature to determine the evaporator superheat.

Compare calculated superheat to the table below for the appropriate unit type and option.

**CAUTION**

**DO NOT OVERCHARGE!**

Refrigerant overcharging leads to excess refrigerant in the condenser coils resulting in elevated compressor discharge pressure.

Table 14 - Acceptable Refrigerant Circuit Values (Metric)

| <b>Air-Cooled Condenser/ Air-Source Heat Pump (°C)</b> |           |           |
|--|-----------|-----------|
| Sub-Cooling  | 6.7-10    | 3.7 – 5.6 |
| Sub-Cooling with Hot Gas Reheat                        | 8.3 -12.2 | 4.4 – 6.7 |
| Superheat  | 4.4-8.3   | 2.2 – 4.4 |
| <b>Water-Cooled Condenser/ Water-Source Heat Pump</b>  |           |           |
| Sub-Cooling  | 2.2-4.4   | 1.2 – 2.2 |
| Sub-Cooling with Hot Gas Reheat                        | 2.2-4.4   | 1.2 – 2.4 |
| Superheat  | 4.4-8.3   | 2.4 – 4.4 |

Table 15 - Acceptable Refrigerant Circuit Values (Imperial)

| <b>Air-Cooled Condenser/ Air-Source Heat Pump (°F)</b> |       |            |
|--|-------|------------|
| Sub-Cooling  | 12-18 | 6.7 - 10   |
| Sub-Cooling with Hot Gas Reheat                        | 15-22 | 8.3 - 12.2 |
| Superheat  | 8-15  | 4.4 - 8.3  |
| <b>Water-Cooled Condenser/ Water-Source Heat Pump</b>  |       |            |
| Sub-Cooling  | 4-8   | 2.2 - 4.4  |
| Sub-Cooling with Hot Gas Reheat                        | 4-8   | 2.2 – 4.4  |
| Superheat  | 8-15  | 4.4 - 8.3  |

Adjusting Sub-Cooling and Superheat Temperatures

The system is overcharged if the sub-cooling fully loaded (low loads on the evaporator result in increased sub-cooling) and the evaporator superheat is within the temperature range as shown in the table above (high superheat results in increased sub-cooling).

Correct an overcharged system by reducing the amount of refrigerant in the system to lower the sub-cooling.

The system is undercharged if the superheat is too high and the sub-cooling is too low

Correct an undercharged system by adding refrigerant to the system to reduce superheat and raise sub-cooling.

If the sub-cooling is correct and the superheat is too high, the TXV may need adjustment to correct the superheat.

Table 16 - R-410A Refrigerant Temperature-Pressure Chart (Metric)

| °C          | KPA   | °C          | KPA    | °C          | KPA    | °C          | KPA    | °C          | KPA    |
|-------------|-------|-------------|--------|-------------|--------|-------------|--------|-------------|--------|
| <b>-6.7</b> | 539.9 | <b>8.3</b>  | 928.8  | <b>23.3</b> | 1473.5 | <b>38.3</b> | 2213.3 | <b>53.3</b> | 3193.8 |
| <b>-6.1</b> | 551.6 | <b>8.9</b>  | 946.0  | <b>23.9</b> | 1496.9 | <b>38.9</b> | 2245.0 | <b>53.9</b> | 3235.8 |
| <b>-5.6</b> | 564.0 | <b>9.4</b>  | 963.2  | <b>24.4</b> | 1521.0 | <b>39.4</b> | 2276.7 | <b>54.4</b> | 3277.9 |
| <b>-5.0</b> | 576.4 | <b>10.0</b> | 980.5  | <b>25.0</b> | 1545.2 | <b>40.0</b> | 2309.1 | <b>55.0</b> | 3320.6 |
| <b>-4.4</b> | 588.8 | <b>10.6</b> | 998.4  | <b>25.6</b> | 1570.0 | <b>40.6</b> | 2341.5 | <b>55.6</b> | 3363.4 |
| <b>-3.9</b> | 601.2 | <b>11.1</b> | 1016.3 | <b>26.1</b> | 1594.8 | <b>41.1</b> | 2374.6 | <b>56.1</b> | 3406.8 |
| <b>-3.3</b> | 614.3 | <b>11.7</b> | 1034.9 | <b>26.7</b> | 1619.6 | <b>41.7</b> | 2408.4 | <b>56.7</b> | 3450.9 |
| <b>-2.8</b> | 627.4 | <b>12.2</b> | 1053.6 | <b>27.2</b> | 1645.1 | <b>42.2</b> | 2442.2 | <b>57.2</b> | 3495.1 |
| <b>-2.2</b> | 640.5 | <b>12.8</b> | 1072.2 | <b>27.8</b> | 1670.7 | <b>42.8</b> | 2476.0 | <b>57.8</b> | 3539.9 |
| <b>-1.7</b> | 654.3 | <b>13.3</b> | 1090.8 | <b>28.3</b> | 1696.2 | <b>43.3</b> | 2510.5 | <b>58.3</b> | 3585.4 |
| <b>-1.1</b> | 667.4 | <b>13.9</b> | 1110.1 | <b>28.9</b> | 1722.4 | <b>43.9</b> | 2544.9 | <b>58.9</b> | 3630.9 |
| <b>-0.6</b> | 681.2 | <b>14.4</b> | 1129.4 | <b>29.4</b> | 1749.3 | <b>44.4</b> | 2580.1 | <b>59.4</b> | 3677.1 |
| <b>0.0</b>  | 695.7 | <b>15.0</b> | 1149.4 | <b>30.0</b> | 1775.5 | <b>45.0</b> | 2616.0 | <b>60.0</b> | 3724.0 |
| <b>0.6</b>  | 709.5 | <b>15.6</b> | 1169.4 | <b>30.6</b> | 1802.4 | <b>45.6</b> | 2651.8 | <b>60.6</b> | 3771.6 |
| <b>1.1</b>  | 724.0 | <b>16.1</b> | 1189.4 | <b>31.1</b> | 1829.9 | <b>46.1</b> | 2688.4 | <b>61.1</b> | 3819.1 |
| <b>1.7</b>  | 738.5 | <b>16.7</b> | 1209.4 | <b>31.7</b> | 1857.5 | <b>46.7</b> | 2724.9 | <b>61.7</b> | 3867.4 |
| <b>2.2</b>  | 752.9 | <b>17.2</b> | 1230.1 | <b>32.2</b> | 1885.8 | <b>47.2</b> | 2761.4 | <b>62.2</b> | 3915.7 |
| <b>2.8</b>  | 768.1 | <b>17.8</b> | 1251.4 | <b>32.8</b> | 1914.1 | <b>47.8</b> | 2798.7 | <b>62.8</b> | 3965.3 |
| <b>3.3</b>  | 783.3 | <b>18.3</b> | 1272.1 | <b>33.3</b> | 1942.3 | <b>48.3</b> | 2836.6 | <b>63.3</b> | 4015.0 |
| <b>3.9</b>  | 798.4 | <b>18.9</b> | 1293.5 | <b>33.9</b> | 1971.3 | <b>48.9</b> | 2874.5 | <b>63.9</b> | 4065.3 |
| <b>4.4</b>  | 814.3 | <b>19.4</b> | 1314.9 | <b>34.4</b> | 2000.2 | <b>49.4</b> | 2913.1 | <b>64.4</b> | 4115.6 |
| <b>5.0</b>  | 829.5 | <b>20.0</b> | 1336.9 | <b>35.0</b> | 2029.9 | <b>50.0</b> | 2952.4 | <b>65.0</b> | 4167.3 |
| <b>5.6</b>  | 846.0 | <b>20.6</b> | 1359.0 | <b>35.6</b> | 2059.5 | <b>50.6</b> | 2991.7 | <b>65.6</b> | 4219.1 |
| <b>6.1</b>  | 861.9 | <b>21.1</b> | 1381.8 | <b>36.1</b> | 2089.2 | <b>51.1</b> | 3031.0 |             |        |
| <b>6.7</b>  | 878.4 | <b>21.7</b> | 1403.8 | <b>36.7</b> | 2120.2 | <b>51.7</b> | 3071.0 |             |        |
| <b>7.2</b>  | 895.0 | <b>22.2</b> | 1427.3 | <b>37.2</b> | 2150.6 | <b>52.2</b> | 3111.7 |             |        |
| <b>7.8</b>  | 911.5 | <b>22.8</b> | 1450.0 | <b>37.8</b> | 2181.6 | <b>52.8</b> | 3153.1 |             |        |

Table 17 - R-410A Refrigerant Temperature-Pressure Chart (Imperial)

| °F | PSIG  | °F | PSIG  | °F  | PSIG  | °F  | PSIG  | °F  | PSIG  |
|----|-------|----|-------|-----|-------|-----|-------|-----|-------|
| 20 | 78.3  | 47 | 134.7 | 74  | 213.7 | 101 | 321.0 | 128 | 463.2 |
| 21 | 80.0  | 48 | 137.2 | 75  | 217.1 | 102 | 325.6 | 129 | 469.3 |
| 22 | 81.8  | 49 | 139.7 | 76  | 220.6 | 103 | 330.2 | 130 | 475.4 |
| 23 | 83.6  | 50 | 142.2 | 77  | 224.1 | 104 | 334.9 | 131 | 481.6 |
| 24 | 85.4  | 51 | 144.8 | 78  | 227.7 | 105 | 339.6 | 132 | 487.8 |
| 25 | 87.2  | 52 | 147.4 | 79  | 231.3 | 106 | 344.4 | 133 | 494.1 |
| 26 | 89.1  | 53 | 150.1 | 80  | 234.9 | 107 | 349.3 | 134 | 500.5 |
| 27 | 91.0  | 54 | 152.8 | 81  | 238.6 | 108 | 354.2 | 135 | 506.9 |
| 28 | 92.9  | 55 | 155.5 | 82  | 242.3 | 109 | 359.1 | 136 | 513.4 |
| 29 | 94.9  | 56 | 158.2 | 83  | 246.0 | 110 | 364.1 | 137 | 520.0 |
| 30 | 96.8  | 57 | 161.0 | 84  | 249.8 | 111 | 369.1 | 138 | 526.6 |
| 31 | 98.8  | 58 | 163.8 | 85  | 253.7 | 112 | 374.2 | 139 | 533.3 |
| 32 | 100.9 | 59 | 166.7 | 86  | 257.5 | 113 | 379.4 | 140 | 540.1 |
| 33 | 102.9 | 60 | 169.6 | 87  | 261.4 | 114 | 384.6 | 141 | 547.0 |
| 34 | 105.0 | 61 | 172.5 | 88  | 265.4 | 115 | 389.9 | 142 | 553.9 |
| 35 | 107.1 | 62 | 175.4 | 89  | 269.4 | 116 | 395.2 | 143 | 560.9 |
| 36 | 109.2 | 63 | 178.4 | 90  | 273.5 | 117 | 400.5 | 144 | 567.9 |
| 37 | 111.4 | 64 | 181.5 | 91  | 277.6 | 118 | 405.9 | 145 | 575.1 |
| 38 | 113.6 | 65 | 184.5 | 92  | 281.7 | 119 | 411.4 | 146 | 582.3 |
| 39 | 115.8 | 66 | 187.6 | 93  | 285.9 | 120 | 416.9 | 147 | 589.6 |
| 40 | 118.1 | 67 | 190.7 | 94  | 290.1 | 121 | 422.5 | 148 | 596.9 |
| 41 | 120.3 | 68 | 193.9 | 95  | 294.4 | 122 | 428.2 | 149 | 604.4 |
| 42 | 122.7 | 69 | 197.1 | 96  | 298.7 | 123 | 433.9 | 150 | 611.9 |
| 43 | 125.0 | 70 | 200.4 | 97  | 303.0 | 124 | 439.6 |     |       |
| 44 | 127.4 | 71 | 203.6 | 98  | 307.5 | 125 | 445.4 |     |       |
| 45 | 129.8 | 72 | 207.0 | 99  | 311.9 | 126 | 451.3 |     |       |
| 46 | 132.2 | 73 | 210.3 | 100 | 316.4 | 127 | 457.3 |     |       |

## Operation

Unit operations should be controlled with thermostat or unit controller, never at the main power supply, except for emergency or complete shutdown of the unit.

### Steam or Hot Water Preheating Operation

Valve control for steam and hot water heating coils are by others. Heating is accomplished by passing steam or hot water through the steam or hot water coil assembly.

### Chilled Water or Non-Compressorized DX Cooling Operation

Controls for chilled water cooling coil and non-compressorized DX coil are by others.

### Packaged DX Cooling Operation and Control

When a call for cooling (G and Y1, Y2, etc.) is made the supply fan motors and compressors will energize.

## WARNING

### COMPRESSOR CYCLING

#### 5 MINUTE MINIMUM OFF TIME

To prevent motor overheating compressors must cycle off for a minimum of 5 minutes.

#### 5 MINUTE MINIMUM ON TIME

To maintain the proper oil level compressors must cycle on for a minimum of 5 minutes.

The cycle rate must not exceed 6 starts per hour.

## Maintenance

(See back of the manual for maintenance log.)

At least once each year, a qualified service technician should check out the unit. Supply fans, evaporator coils and air filters should be inspected monthly.

## WARNING

Improper installation, adjustment, alteration, service or maintenance can cause property damage, personal injury or loss of life. Startup and service must be performed by a Factory Trained Service Technician. A copy of this IOM should be kept with the unit.

Periodically during operation, it is necessary to perform routine service checks on the performance of the unit. This includes checking of the air flow, the air filters, condenser water flow and refrigerant charge.

See Startup section for information on air flow adjustment and refrigerant charge adjustment.

### DX Cooling

Set unit controls to cooling mode of operation with supply fans on. Check the fans for correct operating direction, amperage and voltage. Check compressor operation, rotation, amperage and voltage to the unit nameplate (check the amperage on the load side of the compressor contactor).

### Condensate Drain Pans

Drain pans will have moisture present and require periodic cleaning to prevent microbial growth. Cleaning of the drain pans will also prevent any possible plugging of the drain lines and overflow of the pan itself. Cleaning of the drain pans and inside of the unit should be done only by qualified personnel.

## E-Coated Coil Cleaning

Documented quarterly cleaning of e-coated coils is required to maintain coating warranty coverage.

### **WARNING**

Electric shock hazard. Shut off all electrical power to the unit to avoid shock hazard or injury from rotating parts.

Surface loaded fibers or dirt should be removed prior to water rinse to prevent restriction of airflow. If unable to back wash the side of the coil opposite of the coils entering air side, then surface loaded fibers or dirt should be removed with a vacuum cleaner. If a vacuum cleaner is not available, a *soft non-metallic* bristle brush may be used. In either case, the tool should be applied in the direction of the fins. Coil surfaces can be easily damaged (fin edges bent over) if the tool is applied across the fins.

Use of a water stream, such as a garden hose, against a surface loaded coil will drive the fibers, dirt and salts into the coil. This will make cleaning efforts more difficult. Surface loaded fibers must be completely removed prior to using low velocity clean water rinse.

*Quarterly* cleaning is required to maintain warranty coverage and is essential to maintain the life of an E-coated coil. Coil cleaning shall be part of the unit's regularly scheduled maintenance procedures.

Failure to clean an E-coated coil on the prescribed quarterly cycle will void the warranty and may result in reduced efficiency and durability in the environment.

A routine two-step quarterly coil cleaning is required to maintain warranty.

Step one is to clean the coil with the below approved coil cleaner (see approved products list under the "Recommended Coil Cleaners" section).

Step two is to use the approved salt/chloride remover under the "Recommended Chloride Remover" section to dissolve soluble salts and revitalize the unit. It is very important when cleaning and/or rinsing not to exceed 54.4°C (130°F) and potable water pressure is less than 689.5 kpa (100 psig) to avoid damaging the unit and coil fin edges.

### **CAUTION**

High velocity water from a pressure washer or compressed air should only be used at a very low pressure to prevent fin and/or coil damages. The force of the water or air jet may bend the fin edges and increase airside pressure drop. Reduced unit performance or nuisance unit shutdowns may occur.

Failure to clean an E-coated coil will void the warranty and may result in reduced efficiency and durability.

### **CAUTION**

Harsh chemicals, household bleach, or acid cleaners should not be used to clean outdoor or indoor e-coated coils. These cleaners can be very difficult to rinse out of the coil and can accelerate corrosion and attack the E-coating. If there is dirt below the surface of the coil, use the recommended coil cleaners.

For routine quarterly cleaning, first clean the coil with the below approved coil



cleaner. After cleaning the coils with the approved cleaning agent, use the approved chloride remover to remove soluble salts and revitalize the unit.

*Recommended Coil Cleaner – Step 1*

**GulfCoat™ Coil Cleaner**, assuming it is used in accordance with the manufacturer's directions on the container for proper mixing and cleaning, has been approved for use on E-coated coils to remove mold, mildew, dust, soot, greasy residue, lint and other particulate. Never use any cleaners that are not approved.

*Recommended Chloride Remover – Step 2*

**CHLOR\*RID® Concentrate**, assuming it is used in accordance with the manufacturer's directions on the container for proper mixing, has been approved for use on E-coated coils to remove chlorides/salts & sulfates. Never use any chloride removers that are not approved.

*Warranty Protection – Step 1*

Complete the coil cleaning following these steps:

1. Ensure that the power to the unit is off and locked out.
2. Clean the area around the unit if needed to ensure leaves, grass or loose debris will not be blown into the coil.
3. Remove panels or tops as required gaining access to the coil(s) to be cleaned.
4. Using a pump up sprayer, fill to the appropriate level with potable water and add the correct amount of approved cleaner as per manufacture instructions leaving room for the pump plunger to be reinserted.

**NOTE:** Coils should always be cleaned / back flushed, opposite of airflow to prevent impacting the dirt into the coil.

5. If the coils have heavy dirt, fibers, grass, leaves etc. on the interior or exterior face areas, a vacuum and brush should be used to remove those surface contaminants prior to applying cleaner. The interior floor, drain tray or pan areas should also be vacuumed.
6. Apply the mixed cleaner to coil surfaces using a pressurized pump up sprayer maintaining a good rate of pressure and at a medium size nozzle spray, (not a solid stream and not a wide fan but somewhere in the middle). Work in sections/panels ensuring that all areas are covered and kept wetted.
7. Apply the cleaner to unit interior air exiting side coil surfaces first. Work in sections/panels moving side to side and from top to bottom.
8. Generously soak coils by spraying cleaner directly on and into the fin pack section to be cleaned and allow the cleaning solution to soak for 5 to 10 minutes.
9. Using pressurized potable water, (<689.5 kpa [<100 psi]), rinse the coils and continue to always work in sections/panels. Start at the top of the coil and slowly move vertically downward to the bottom. Then, staying in the same vertical area, slowly move back up to the top where you started. Now move over slightly overlapping the area just completed and repeat above. Continue until all coil areas on the inside of the unit have been rinsed.
10. Complete steps 5-9 for the exterior air entering side of the coils.
11. Final rinse – Now complete a quick rinse of both sides of the coil including the headers, piping, u- bends and hairpins.
12. If the coil has a drain pan or unit floor that is holding rinse water or cleaner, extra time and attention will need to be taken in those areas to ensure a proper rinse has been completed.

### Warranty Protection – Step 2

Complete the coil chloride (salt) removal following these steps:

1. CHLOR\*RID® is a concentrate to be used for both normal inland applications at a 100:1 mix ratio OR for severe coastal applications 50:1 mix ratio with potable water, (2.56 ounces of Chlor\*rid to 1 gal of water). Using a pump up sprayer, fill to the appropriate level with potable water and add the correct amount of CHLOR\*RID® salt remover leaving room for the pump plunger to be reinserted.
2. Apply CHLOR\*RID® to all external coil surfaces using a pressurized pump up sprayer maintaining a good rate of pressure and at a medium size nozzle spray, (not a solid stream and not a wide fan but somewhere in the middle). Work in sections/panels ensuring that all areas are covered and kept wetted.
3. Generously soak coils by spraying CHLOR\*RID® directly on and into the fin pack section. Let stand for 5 to 10 minutes keeping the area wetted. Do not allow to dry before rinsing.
4. Using pressurized potable water, (<689.5 kpa [<100 psi]), rinse the CHLOR\*RID® and dissolved chlorides/salts off of the coils continuing to always work in sections/panels.
5. Starting at the top of the coil, begin rinsing the coil from side to side until you reach the bottom. Repeat as many times as is necessary to ensure all coil sections/panels have been completed and are thoroughly rinsed.
6. Reinstall all panels and tops that were removed.

### Supply Fans

#### CAUTION

Blower wheels and bands must be inspected for excessive dust build up periodically and cleaned if required. Excessive dust build up on blower wheels may cause an unbalanced state; leading to vibration and/or component failure. Damages due to excessive dust build up will not be covered under factory warranty.

#### WARNING

Electric shock hazard. Shut off all electrical power to the unit to avoid shock hazard or injury from rotating parts.

#### *Lubrication*

All original blower motors and bearings are furnished with factory lubrication. Some applications will require that bearings be re-lubricated periodically. The schedule will depend on the operating duty, temperature variations or other severe atmospheric conditions.

Bearings should be re-lubricated when at normal operating temperatures, but not running. Rotate the fan shaft by hand and add only enough grease to purge the seals. DO NOT OVERLUBRICATE.

Recommended greases are:  
SHELL OIL - DOLIUM R  
CHEVRON OIL - SRI No. 2  
TEXACO INC. - PREMIUM R

## Phase and Brownout Protection Module



The DPM is a Digital Phase Monitor that monitors line voltages from 200VAC to 240VAC 1 $\phi$  and 200VAC to 600VAC 3 $\phi$ . The DPM is 50/60 Hz self-sensing. DPM should be wired according to unit specific wiring diagram include in the control compartment

When the DPM is connected to the line voltage, it will monitor the line and if everything is within the setup parameters, the output contacts will be activated. If the line voltages fall outside the setup parameters, the output relay will be de-energized after the trip delay.

Once the line voltages recover, the DPM will re-energize the output relay after the restart time delay. All settings and the last 4 faults are retained, even if there is a complete loss of power.

## DPM Setup Procedure

With the supply voltage active to the module, you can setup all of the DPM's settings without the line voltage connected.

To change the setpoint parameters use the right arrow key to advance forward through the setpoint parameters and the left arrow to backup if needed. When each parameter is displayed use the up/down keys to change and set the parameter.

After adjustments are made or if no adjustments are made it will take 2 to 4 minutes before the DPM energizes the output relay unless there is an out of tolerance issue with the incoming line voltage.

## Recommended Default Set-up

|                     |                  |
|---------------------|------------------|
| Line Voltage        | 460VAC, 3 $\phi$ |
| Over & Undervoltage | $\pm 10\%$       |
| Trip Time Delay     | 5 Seconds        |
| Re-Start Time Delay | 2 Minutes        |
| Phase Imbalance     | 5%               |

## Screens

### Manufacturer's Screen

R-K Electronics

DPM v0.0.00

**Average Voltage Screen V<sub>Avg</sub>    I<sub>mb</sub>    Hz**  
460        0        60    off

**Default – the default screen shows the real time voltage detected in each of the 3 phases:**

A-B   B-C   C-A  
460   459   461   ON

**Voltage Selection Screen (Vertical Format) Default = 460V, 3Ø**

200, 1Ø; 208, 1Ø; 220, 1Ø; 230, 1Ø; 240, 1Ø;  
200, 3Ø; 208, 3Ø; 220, 3Ø; 230, 3Ø; 240, 3Ø; 380, 3Ø; 415, 3Ø; 440, 3Ø;  
460, 3Ø; 480 3Ø; 575, 3Ø; 600, 3Ø;

**Over/Under voltage Percentage Screen (Vertical Format) Default = 10%**

7% 8% 9% 10% 11% 12% 13% 14% & 15%

**Trip Time Delay Screen (Vertical Format) Default = 5 sec**

2S, 3S, 4S, 5S, 6S, 27S, 8S, 9S & 10S

**Re-Start Time Delay Screen (Vertical Format) Default = 2 sec**

Manual, 2S, 3S, 4S, 5S, 6S, 7S, 8S, 9S, 10S, 30S, 1M, 2M, 3M & 4M

**Phase Imbalance Percentage Screen (Vertical Format) Default = 5%**

3% 4% 5% 6% 7% 8% 9% & 10%

**Fault Screen (Vertical Format)**

“0” most recent faults, “1” previous fault “2” third oldest fault & “3” fourth oldest fault.

### Fault Words:

“Phase a Loss”        (There is no voltage sensed on 3-L1/S)  
“Voltage Low”        (Average line voltage is less than selected Undervoltage Percentage)  
“Voltage High”        (Average line voltage is more than selected Overvoltage Percentage)  
“Imbalance”        (One phase is lower than the average voltage by more than the Imbalance percentage)  
“Phase Loss”        (One phase is more than 30% below the Line Voltage selection)  
“Bad Rotation”        (The phase rotation sequence is reversed)  
“Bad Freq”        (Line frequency out of allowable range of 45 to 65 Hz)

## Filter Replacement

Monthly filter inspection is required to maintain optimum unit efficiency.

panel and pull filters straight out to inspect all of the filters. Replace filters with the size indicated on each filter or as shown in the tables below. Arrow on the replacement filters must point towards the blower.

|   |
|---|
|  <b>WARNING</b>                      |
| Electric shock hazard. Shut off all electrical power to the unit to avoid shock hazard or injury from rotating parts. |

It is strongly recommended that filter media be replaced monthly. Filters are located upstream of the evaporator coil. Open access

Table 18 - 23-35 tons, Pre Filters

| Feature 6A | Qty. Size (cm) [in.]                   | Type           |
|------------|--|----------------|
| 0          | No Pre Filters                         |                |
| A          | (9) 50.8 x 50.8 x 5.1<br>[20 x 20 x 2] | Pleated MERV 8 |

Table 19 - 45-70 tons, Pre Filters

| Feature 6A | Qty. Size (cm) [in.]                    | Type           |
|------------|---|----------------|
| 0          | No Pre Filters                          |                |
| A          | (18) 50.8 x 50.8 x 5.1<br>[20 x 20 x 2] | Pleated MERV 8 |

Table 20 - 23-35 tons, Unit Filters

| Feature 6B | Qty. Size (cm) [in.]                    | Type            |
|------------|---|-----------------|
| 0          | (9) 50.8 x 50.8 x 5.1<br>[20 x 20 x 2]  | Pleated MERV 8  |
| A          | (9) 50.8 x 50.8 x 10.2<br>[20 x 20 x 4] | Pleated MERV 8  |
| B          | (9) 50.8 x 50.8 x 10.2<br>[20 x 20 x 4] | Pleated MERV 11 |
| C          | (9) 50.8 x 50.8 x 10.2<br>[20 x 20 x 4] | Pleated MERV 13 |
| D          | (9) 50.8 x 50.8 x 10.2<br>[20 x 20 x 4] | Pleated MERV 14 |

Table 21 - 45-70 tons, Unit Filters

| Feature 6B | Qty. Size (cm) [in.]                     | Type            |
|------------|--|-----------------|
| 0          | (18) 50.8 x 50.8 x 5.1<br>[20 x 20 x 2]  | Pleated MERV 8  |
| A          | (18) 50.8 x 50.8 x 10.2<br>[20 x 20 x 4] | Pleated MERV 8  |
| B          | (18) 50.8 x 50.8 x 10.2<br>[20 x 20 x 4] | Pleated MERV 11 |
| C          | (18) 50.8 x 50.8 x 10.2<br>[20 x 20 x 4] | Pleated MERV 13 |
| D          | (18) 50.8 x 50.8 x 10.2<br>[20 x 20 x 4] | Pleated MERV 14 |

**Replacement Parts**

Parts for AAON equipment may be obtained from your local AAON representative. Reference the unit serial number and part number when ordering parts.

**AAON Warranty, Service, and Parts Department**

2424 S. Yukon Ave.  
Tulsa, OK 74107  
Ph: 918-382-6450  
Fax: 918-382-6364  
www.aon.com

**Note:** Before calling, technician should have model and serial number of the unit available for the service department to help answer questions regarding the unit.

Appendix A - Heat Exchanger Corrosion Resistance

**Corrosion Resistance of Copper and Stainless Steel in Brazed Plate Heat Exchangers**

**- Points to Measure and Check in a Water Analysis**

The resistance guide below provides the corrosion resistance of stainless steel type AISI 316 and pure Copper (99.9%) in water, to a number of important chemical factors. The actual corrosion is a very complex process influenced by many different factors in combination.

Explanations: + Good resistance under normal conditions

0 Corrosion problems may occur especially when more factors are valued 0

- Use is not recommended

| Water Containing  | Concentration (mg/l or ppm) | Time Limits - Analyze Before | AISI 316 | SMO 254 | Copper Alloy | Nickel Alloy |
|---|-----------------------------|------------------------------|----------|---------|--------------|--------------|
| Alkalinity (HCO <sub>3</sub> <sup>-</sup> )                   | < 70                        | Within 24 Hours              | +        | +       | 0            | +            |
|   | 70-300                      |                              | +        | +       | +            | +            |
|   | > 300                       |                              | +        | +       | 0/+          | +            |
| Sulfate (SO <sub>4</sub> <sup>-2</sup> )                      | < 70                        | No Limit                     | +        | +       | +            | +            |
|   | 70-300                      |                              | +        | +       | 0/-          | +            |
|   | > 300                       |                              | 0        | 0       | -            | +            |
| HCO <sub>3</sub> <sup>-</sup> / SO <sub>4</sub> <sup>2-</sup> | > 1.0                       | No Limit                     | +        | +       | +            | +            |
|   | < 1.0                       |                              | +        | +       | 0/-          | +            |
| Electrical Conductivity                                       | < 10µS/cm                   | No Limit                     | +        | +       | 0            | +            |
|   | 10-500 µS/cm                |                              | +        | +       | +            | +            |
|   | > 500 µS/cm                 |                              | +        | +       | 0            | +            |
| pH  | < 6.0                       | Within 24 Hours              | 0        | 0       | 0            | +            |
|   | 6.0-7.5                     |                              | 0/+      | +       | 0            | +            |
|   | 7.5-9.0                     |                              | +        | +       | +            | +            |
|   | > 9.0                       |                              | +        | +       | 0            | +            |
| Ammonium (NH <sub>4</sub> <sup>+</sup> )                      | < 2                         | Within 24 Hours              | +        | +       | +            | +            |
|   | 2-20                        |                              | +        | +       | 0            | +            |
|   | > 20                        |                              | +        | +       | -            | +            |
| Chlorides (Cl <sup>-</sup> )*                                 | < 300                       | No Limit                     | +        | +       | +            | +            |
|   | > 300                       |                              | 0        | +       | 0/+          | +            |
| Free Chlorine (Cl <sub>2</sub> )                              | < 1                         | Within 5 Hours               | +        | +       | +            | +            |
|   | 1-5                         |                              | +        | +       | 0            | +            |
|   | > 5                         |                              | 0/+      | +       | 0/-          | +            |
| Hydrogen Sulfide (H <sub>2</sub> S)                           | < 0.05                      | No Limit                     | +        | +       | +            | +            |
|   | > 0.05                      |                              | +        | +       | 0/-          | +            |
| Free (aggressive) Carbon Dioxide (CO <sub>2</sub> )           | < 5                         | No Limit                     | +        | +       | +            | +            |
|   | 5-20                        |                              | +        | +       | 0            | +            |
|   | > 20                        |                              | +        | +       | -            | +            |

\*See Also Chloride Content Table

| Water Containing           | Concentration (mg/l or ppm) | Time Limits - Analyze Before | AISI 316 | SMO 254 | Copper Alloy | Nickel Alloy |
|----------------------------|-----------------------------|------------------------------|----------|---------|--------------|--------------|
| Total Hardness (°dH)       | 4.0-8.5                     | No Limit                     | +        | +       | +            | +            |
| Nitrate (NO <sub>3</sub> ) | < 100                       | No Limit                     | +        | +       | +            | +            |
|                            | > 100                       |                              | +        | +       | 0            | +            |
| Iron (Fe)                  | < 0.2                       | No Limit                     | +        | +       | +            | +            |
|                            | > 0.2                       |                              | +        | +       | 0            | +            |
| Aluminum (Al)              | < 0.2                       | No Limit                     | +        | +       | +            | +            |
|                            | > 0.2                       |                              | +        | +       | 0            | +            |
| Manganese (Mn)             | < 0.1                       | No Limit                     | +        | +       | +            | +            |
|                            | > 0.1                       |                              | +        | +       | 0            | +            |

#### Chloride Content

| Chloride Content | Maximum Temperature |              |               |               |
|------------------|---------------------|--------------|---------------|---------------|
|                  | 60°C (140°F)        | 80°C (176°F) | 120°C (248°F) | 130°C (266°F) |
| = 10 ppm         | SS 304              | SS 304       | SS 304        | SS 316        |
| = 25 ppm         | SS 304              | SS 304       | SS 316        | SS 316        |
| = 50 ppm         | SS 304              | SS 316       | SS 316        | Ti / SMO 254  |
| = 80 ppm         | SS 316              | SS 316       | SS 316        | Ti / SMO 254  |
| = 150 ppm        | SS 316              | SS 316       | Ti / SMO 254  | Ti / SMO 254  |
| = 300 ppm        | SS 316              | Ti / SMO 254 | Ti / SMO 254  | Ti / SMO 254  |
| > 300 ppm        | Ti / SMO 254        | Ti / SMO 254 | Ti / SMO 254  | Ti / SMO 254  |



## SA Series Startup Form

|                           |             |
|---------------------------|-------------|
| Job Name: _____           | Date: _____ |
| Address: _____            |             |
|                           |             |
| Model Number: _____       |             |
| Serial Number: _____      | Tag: _____  |
| Startup Contractor: _____ |             |
| Address: _____            |             |
|                           |             |
| Phone: _____              |             |

### ***Pre Startup Checklist***

|   |  |
|---|--|
| Installing contractor should verify the following items.                                |  |
| 1. Is there any visible shipping damage?  | <input type="checkbox"/> Yes <input type="checkbox"/> No |
| 2. Is the unit level?   | <input type="checkbox"/> Yes <input type="checkbox"/> No |
| 3. Are the unit clearances adequate for service and operation?                          | <input type="checkbox"/> Yes <input type="checkbox"/> No |
| 4. Do all access doors open freely and are the handles operational?                     | <input type="checkbox"/> Yes <input type="checkbox"/> No |
| 5. Have all shipping braces been removed?   | <input type="checkbox"/> Yes <input type="checkbox"/> No |
| 6. Have all electrical connections been tested for tightness?                           | <input type="checkbox"/> Yes <input type="checkbox"/> No |
| 7. Does the electrical service correspond to the unit nameplate?                        | <input type="checkbox"/> Yes <input type="checkbox"/> No |
| 8. On 208/230V units, has transformer tap been checked?                                 | <input type="checkbox"/> Yes <input type="checkbox"/> No |
| 9. Has overcurrent protection been installed to match the unit nameplate requirement?   | <input type="checkbox"/> Yes <input type="checkbox"/> No |
| 10. Have all set screws on the fans been tightened?                                     | <input type="checkbox"/> Yes <input type="checkbox"/> No |
| 11. Do all fans rotate freely?  | <input type="checkbox"/> Yes <input type="checkbox"/> No |
| 12. Does the field water piping to the unit appear to be correct per design parameters? | <input type="checkbox"/> Yes <input type="checkbox"/> No |
| 13. Is all copper tubing isolated so that it does not rub?                              | <input type="checkbox"/> Yes <input type="checkbox"/> No |
| 14. Are air filters installed with proper orientation?                                  | <input type="checkbox"/> Yes <input type="checkbox"/> No |
| 15. Have condensate drain and p-trap been connected?                                    | <input type="checkbox"/> Yes <input type="checkbox"/> No |

### **Ambient Temperature**

|  |  |
|--|--|
| Ambient Dry Bulb Temperature _____ °C/°F | Ambient Wet Bulb Temperature _____ °C/°F |
|--|--|

**Supply Fan Assembly**

|                                    |    |   |  |                      |  |
|------------------------------------|----|---|--|----------------------|--|
| Alignment <input type="checkbox"/> |    | Check Rotation <input type="checkbox"/> |  | Nameplate Amps _____ |  |
| Number                             | hp | L1                                      | L2   | L3                   |  |
| 1                                  |    |   |  |                      |  |
| 2                                  |    |   |  |                      |  |
| 3                                  |    |   |  |                      |  |
| 4                                  |    |   |  |                      |  |
| Band Size _____                    |    |   | VAV Controls _____                                   |                      |  |
| VFD Frequency _____                |    |   | Springs Operating Correctly <input type="checkbox"/> |                      |  |

**Compressors/DX Cooling**

|   |    |    |    |                             |                               |
|---|----|----|----|-----------------------------|-------------------------------|
| Check Rotation <input type="checkbox"/> |    |    |    |                             |                               |
| Number                                  | L1 | L2 | L3 | Head Pressure<br>KPA (PSIG) | Suction Pressure<br>KPA(PSIG) |
| 1                                       |    |    |    |                             |                               |
| 2                                       |    |    |    |                             |                               |
| 3                                       |    |    |    |                             |                               |
| 4                                       |    |    |    |                             |                               |

**Refrigeration System 1 - Cooling Mode**

|           | Pressure | Saturated Temperature | Line Temperature | Sub-cooling | Superheat |
|-----------|----------|-----------------------|------------------|-------------|-----------|
| Discharge |          |                       |                  | N/A         | N/A       |
| Suction   |          |                       |                  | N/A         |           |
| Liquid    |          |                       |                  |             | N/A       |

**Refrigeration System 2 - Cooling Mode**

|           | Pressure | Saturated Temperature | Line Temperature | Sub-cooling | Superheat |
|-----------|----------|-----------------------|------------------|-------------|-----------|
| Discharge |          |                       |                  | N/A         | N/A       |
| Suction   |          |                       |                  | N/A         |           |
| Liquid    |          |                       |                  |             | N/A       |

**Refrigeration System 3 - Cooling Mode**

|           | Pressure | Saturated Temperature | Line Temperature | Sub-cooling | Superheat |
|-----------|----------|-----------------------|------------------|-------------|-----------|
| Discharge |          |                       |                  | N/A         | N/A       |
| Suction   |          |                       |                  | N/A         |           |
| Liquid    |          |                       |                  |             | N/A       |

**Refrigeration System 4 - Cooling Mode**

|           | Pressure | Saturated Temperature | Line Temperature | Sub-cooling | Superheat |
|-----------|----------|-----------------------|------------------|-------------|-----------|
| Discharge |          |                       |                  | N/A         | N/A       |
| Suction   |          |                       |                  | N/A         |           |
| Liquid    |          |                       |                  |             | N/A       |

**Refrigeration System 1 - Heating Mode (Heat Pump Only)**

|           | Pressure | Saturated Temperature | Line Temperature | Sub-cooling | Superheat |
|-----------|----------|-----------------------|------------------|-------------|-----------|
| Discharge |          |                       |                  | N/A         | N/A       |
| Suction   |          |                       |                  | N/A         |           |
| Liquid    |          |                       |                  |             | N/A       |

**Refrigeration System 2 - Heating Mode (Heat Pump Only)**

|           | Pressure | Saturated Temperature | Line Temperature | Sub-cooling | Superheat |
|-----------|----------|-----------------------|------------------|-------------|-----------|
| Discharge |          |                       |                  | N/A         | N/A       |
| Suction   |          |                       |                  | N/A         |           |
| Liquid    |          |                       |                  |             | N/A       |

**Refrigeration System 3 - Heating Mode (Heat Pump Only)**

|           | Pressure | Saturated Temperature | Line Temperature | Sub-cooling | Superheat |
|-----------|----------|-----------------------|------------------|-------------|-----------|
| Discharge |          |                       |                  | N/A         | N/A       |
| Suction   |          |                       |                  | N/A         |           |
| Liquid    |          |                       |                  |             | N/A       |

**Refrigeration System 4 - Heating Mode (Heat Pump Only)**

|           | Pressure | Saturated Temperature | Line Temperature | Sub-cooling | Superheat |
|-----------|----------|-----------------------|------------------|-------------|-----------|
| Discharge |          |                       |                  | N/A         | N/A       |
| Suction   |          |                       |                  | N/A         |           |
| Liquid    |          |                       |                  |             | N/A       |

**Unit Configuration**

|   |   |
|---|---|
| Water-Cooled Condenser <input type="checkbox"/> | Air-Cooled Condenser <input type="checkbox"/>   |
| No Water Leaks <input type="checkbox"/>         | Condenser Safety Check <input type="checkbox"/> |
| Water Flow _____ gpm                            |   |
| Water Inlet Temperature _____ °C/°F             | Water Outlet Temperature _____ °C/°F            |

**Water/Glycol System**

|  |  |
|--|--|
| 1. Has the entire system been flushed and pressure checked?        | <input type="checkbox"/> Yes <input type="checkbox"/> No |
| 2. Has the entire system been filled with fluid?                   | <input type="checkbox"/> Yes <input type="checkbox"/> No |
| 3. Has air been bled from the heat exchangers and piping?          | <input type="checkbox"/> Yes <input type="checkbox"/> No |
| 4. Is the glycol the proper type and concentration (N/A if water)? | <input type="checkbox"/> Yes <input type="checkbox"/> No |
| 5. Is there a minimum load of 50% of the design load?              | <input type="checkbox"/> Yes <input type="checkbox"/> No |
| 6. Has the water piping been insulated?                            | <input type="checkbox"/> Yes <input type="checkbox"/> No |
| 7. What is the freeze point of the glycol (N/A if water)? _____    |  |

**Air-Cooled Condenser Fans**

| Alignment <input type="checkbox"/> |    | Check Rotation <input type="checkbox"/> |    | Nameplate Amps _____ |
|------------------------------------|----|---|----|----------------------|
| Number                             | hp | L1                                      | L2 | L3                   |
| 1                                  |    |   |    |                      |
| 2                                  |    |   |    |                      |
| 3                                  |    |   |    |                      |
| 4                                  |    |   |    |                      |
| 5                                  |    |   |    |                      |
| 6                                  |    |   |    |                      |





**August 2023**

Start of new UL-60335 IOM. Added UL-60335 information for text, warnings, and tables. Added metric conversions to all imperial units in the document. Added metric pressure-temperature tables.

**May 2024**

Added additional warnings. Added KAIC tables. Reviewed to confirm information in feature string is still accurate.



**AAON**  
**203 Gum Springs Rd.**  
**Longview, TX 75602-1721**  
**www.AAON.com**

**SA Series**  
**Installation, Operation &**  
**Maintenance**  
**J000236 (V04330)**  
**Rev. A 240502**

**Factory Technical Support: 918-382-6450**

**Note:** Before calling Technical Support, please have the model and serial number of the unit available.

**Parts:** For replacement parts please contact your local AAON Representative.

It is the intent of AAON to provide accurate and current product information. However, in the interest of product improvement, AAON reserves the right to change pricing, specifications, and/or design of its product without notice, obligation, or liability.